

Diastereoselective Reactions of Chiral Allyl- and Allenylsilanes with Activated C=X π -Bonds

Craig E. Masse and James S. Panek*

Department of Chemistry, Metcalf Center for Science and Engineering, Boston University, Boston, Massachusetts 02215

Received February 7, 1995 (Revised Manuscript Received April 27, 1995)

Contents

I. Introduction	1293
II. Characteristics of Organosilane Compounds which Affect Reaction Selectivity and Reactivity	1294
III. Silicon Bonded to an Adjacent Participating π -Bond	1295
Chiral Allylsilanes—Acyclic Diastereoselective Reactions	1295
A. Stereochemistry of Electrophilic Additions to Chiral Allylsilanes	1295
B. First Examples of Chiral Allylic Silanes in Acyclic Stereocontrol	1296
C. Reactions with Acetals	1298
D. Reactions with Aldehydes	1300
E. Reactions with α,β -Unsaturated Carbonyl Compounds	1303
F. Reactions with Acyliminium Ions	1303
[3 + 2]-Annulation Processes	1304
G. Reactions with α,β -Unsaturated Carbonyl Compounds	1304
H. Reactions with Activated C=N π -Bonds	1306
I. Reactions with Activated C=X π -Bonds	1306
J. Reactions with Other Electrophiles	1308
IV. Silicon Bonded to a Participating π -Bond	1310
Chiral Allenylsilanes—Acyclic Diastereoselective Reactions	1310
A. Reactions with Aldehydes and Ketones	1310
[3 + 2]-Annulation Processes	1311
B. Reactions with α,β -Unsaturated Carbonyl Compounds	1312
C. Reactions with Aldehydes	1313
D. Reactions with Activated C=N π -Bonds	1313
V. Pentacoordinate Allylsilanes	1313
VI. Summary	1315
VII. Acknowledgments	1315
VIII. References and Notes	1315

I. Introduction

Chiral allylmetal reagents are becoming increasingly important in synthetic organic chemistry as reagents for acyclic stereocontrol and stereoselective annulation processes. In this regard, a wide range of useful methods have been developed for the stereoselective synthesis of complex organic molecules utilizing allylic metal reagents. Many of these methods have successfully addressed the synthesis of complex natural products belonging to the polypropionate and ansamycin classes of molecules. By way of analogy, the chiral crotyl- and allylmetal reagents may be thought of as propionate and acetate-enolate



Craig E. Masse was born in 1971 in Lowell, MA. He received his B.S. degree (*summa cum laude*) in chemistry in 1994 from the University of Massachusetts—Lowell, where he did undergraduate research with Dr. Sukant K. Tripathy. This past year, he accepted a Boston University Presidential Fellowship to pursue a Ph.D. in synthetic organic chemistry under the direction of Professor James S. Panek. His research efforts are directed toward the asymmetric total synthesis of polypropionate derived natural products utilizing chiral crotylsilane bond construction methodology.



James Panek was born in Buffalo, NY, in 1956. He received his B.S. degree from the State University of New York at Buffalo in 1979 and his Ph.D. in Medicinal Chemistry from the University of Kansas in 1984 under the supervision of Professor Dale Boger. After postdoctoral study with Professor Samuel Danishefsky at Yale University as an NIH Postdoctoral Fellow, he assumed the position of Assistant Professor of Chemistry at Boston University in 1986. His research interests are primarily concerned with the area of organic synthesis. His research group is engaged in the development of new reaction methodology concerned with acyclic stereocontrol as well as the application of these methods to the asymmetric synthesis of natural products and complex organic molecules.

equivalents respectively, for the diastereo- and/or enantioselective carbon-carbon bond formation in the construction of homoallylic alcohols.¹ These reagents have played a complementary role to the asymmetric metal enolate-based aldol process and consequently are among the most important groups

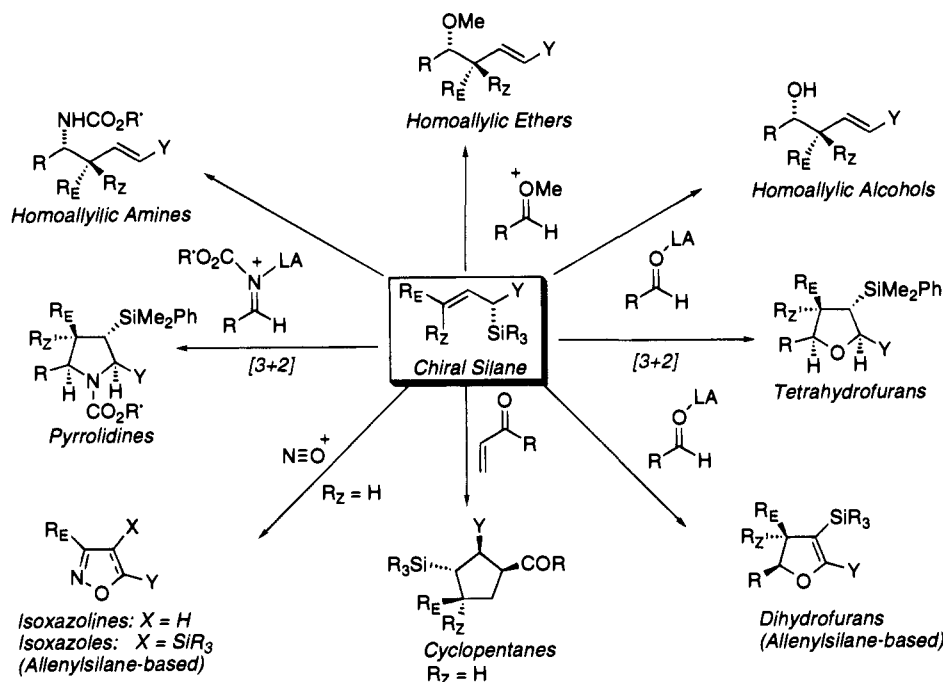

Figure 1. General stereoselective processes of chiral allylsilane reagents.

of organometallic reagents available for the formation of stereochemically well-defined homoallylic alcohols.² Despite the enormous utility that allylsilanes have demonstrated in organic chemistry, relatively few examples have been reported addressing the issue of acyclic enantiotopic face selectivity in addition reactions to C=X π -bonds.³ Prior to the early 1980s the development of these reagents was restricted by the lack of reaction methodologies available for the production of multigram quantities of enantiomerically pure reagents with the unequivocal assignment of absolute configuration.⁴ Therefore, research efforts that provided new methods for the production of such reagents, making possible the development of new asymmetric transformations, necessarily constituted valuable contributions to the field of organic synthesis.⁵

Although many of the chiral silane reagents covered in this review are resolved into enantiomerically pure reagents, chiral racemic reagents have also been included. The complementary class of chiral stannane-based reagents containing an adjacent (allylic) double bond are not covered here but have recently been reviewed.^{6,60} Similarly, the homologous vinylsilanes have not been included in this review. This review will focus on processes related to acyclic stereocontrol as well as stereocontrolled annulations reactions which utilize chiral allyl- and allenylsilane reagents possessing C-centered chirality. The present review contains coverage of the more recent developments and the utility of chiral silane reagents in stereoselective bond forming processes. Although recently reviewed by Chan and Wang,^{3h} we have also included some recent contributions of silane reagents where the chirality is Si-centered. The review has been organized in order of the type of stabilized nucleophilic equivalent and the issues of selectivity are treated within the context of each subsection treating a specific type of nucleophile equivalent.

Particular attention has been given to the treatment of σ - π -bonded silicon-stabilized nucleophiles of allylsilanes, allenylsilanes, and crotylsilanes. Emphasis has been placed on practical diastereo- and enantioselective synthetic methods and yields, reaction conditions and proposed mechanisms are frequently discussed. Reactions where products from silicon-stabilized nucleophile equivalents have been isolated in low yield or are byproducts from the reaction have been omitted. It is useful to describe the two general types of reaction pathways which predominate the stereoselective processes of the silicon-derived chiral reagents. In this regard, the chiral silane reagents participate in either an addition-elimination (stereoselective condensation) reaction or an annulation reaction. To clarify this issue, the reaction manifold is illustrated in Figure 1.

II. Characteristics of Organosilane Compounds which Affect Reaction Selectivity and Reactivity

Organic silicon compounds display a multitude of functions in organic synthesis.¹ The usefulness of organosilicon reagents in stereoselective bond-forming reactions can be attributed to the large number of functional groups and reactions conditions that can be accommodated by this metal and its ability to function as an electron donor and acceptor. The reactivity and selectivity of reactions involving organosilanes is dependent upon their steric components and associated electronic effects. The electronic components of silicon can be placed into four categories: (i) inductive effects,⁷ (ii) field effects,⁷⁻⁹ (iii) p-d π -bonding,^{7,10,11} and (iv) hyperconjugative effects.^{3a,f,7} However, the factors which influence selectivity in reactions involving organosilicon compounds are not solely a result of electronic contributions but rather a combination of variables including a steric component.¹²

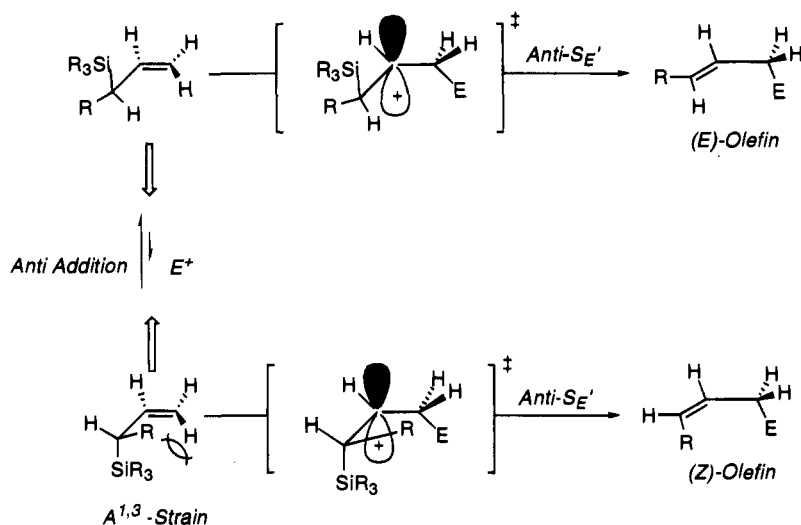

Figure 2. Stereochemistry of electrophilic additions to chiral allylsilanes.

III. Silicon Bonded to an Adjacent Participating π -Bond

The spectrum of silicon-stabilized nucleophiles containing σ -bonded silyl groups attached to a participating π -bond and their use in organic synthesis has grown considerably over the last several years. In this context, allyl-, crotyl-, and allenylsilanes have emerged as remarkably useful and versatile reagents for the regio- and stereoselective formation of carbon-carbon bonds. This section will discuss the stereochemical aspects of σ - π -bonded silicon-stabilized nucleophiles in addition reactions to $C=X$ π -systems. Although beyond the scope of the present review, excellent reviews have appeared covering vinylsilane^{3a,c,13} and alkynylsilane-terminated cyclization reactions. In addition, Fleming has authored an exhaustive review on the chemistry of allylsilanes^{3a} and recent reviews by Yamamoto^{3e} and Sarkar^{3g} also include sections on allylsilanes. The following sections (A–J) will provide an overview of the mechanistic proposals currently used to rationalize the regio- and stereoselectivities in addition reactions involving allylsilanes and focus on recent and significant contributions to this area of research. Allylsilanes have proven to be an exceedingly useful class of organometallic reagents and continue to show enormous potential in stereoselective bond formation reactions. They participate in both catalyzed and uncatalyzed addition reactions with a wide range of $C=X$ π -systems (electrophiles). Their use as carbon nucleophiles has received, and deservedly so, much attention due to the large number of chemical transformations that can be achieved and the wide range of reaction conditions that can be tolerated by these reagents.

Chiral Allylsilanes—Acyclic Diastereoselective Reactions

A. Stereochemistry of Electrophilic Additions to Chiral Allylsilanes

The electrophilic addition reactions of chiral, acyclic allylsilanes are perhaps best rationalized through an *anti*- S_E' mode of addition.¹⁴ The stereochemistry of these reactions has been interpreted through ground-

state conformational energies of the allylsilane rotamers and the electrophile component. As is illustrated in Figure 2, the preferred ground-state conformer orients the smallest substituent, usually hydrogen, in a position eclipsing (inside) the adjacent double bond.¹⁵ The bulky silicon group may direct the approach of the electrophile to the opposite face of the π -system, generating a secondary carbocation. A bond rotation then follows orienting the C–Si bond coplanar to empty p-orbital, providing stabilization through hyperconjugation to the electron-deficient center. Conventional wisdom suggests that this additional stabilization is responsible for the high levels of selectivity that are observed in the elimination reaction (second step) to form the *E* double bond as illustrated in Figure 2. The formation of a *Z* double bond is disfavored as a result of $A^{1,3}$ -strain^{15c} between the alkyl substituent of the stereocenter and the vinyl hydrogen.

Simple Diastereoselection in Lewis Acid-Promoted Additions of Allylsilanes. The relative stereochemical outcome of these reactions has been interpreted through the use of two related transition state models. These models use very different orientations of the reacting double bonds to explain the stereoselectivities. Both models can be referred to as “open” transition states which preclude the involvement of a Lewis acid in preorganization of the reaction components. The first is referred to as an “extended” or antiperiplanar transition state model where the participating π -bonds are oriented at 180° to each other (Figure 3). In this instance, the carbon nucleophile and the activated carbonyl (aldehyde) are in an *anti* relationship to each other and also coplanar. Using this model, which is based on steric destabilizing interactions, transition states **I** and **II** are favored because the steric interactions between the aldehyde substituent and the vinyl methyl group are diminished. The destabilizing interactions created by these substituents are greatest for transition states **III** and **IV** which places them in a *gauche* orientation.^{3a}

An alternative model using the transition states **V–XII** has been proposed to rationalize the selectivities in these reactions (Figure 4). This model re-

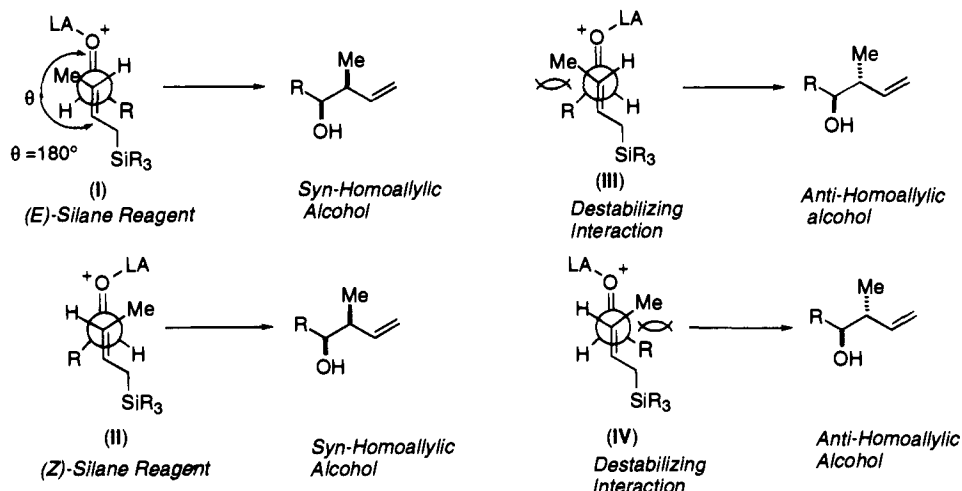

Figure 3. Antiperiplanar transition states.

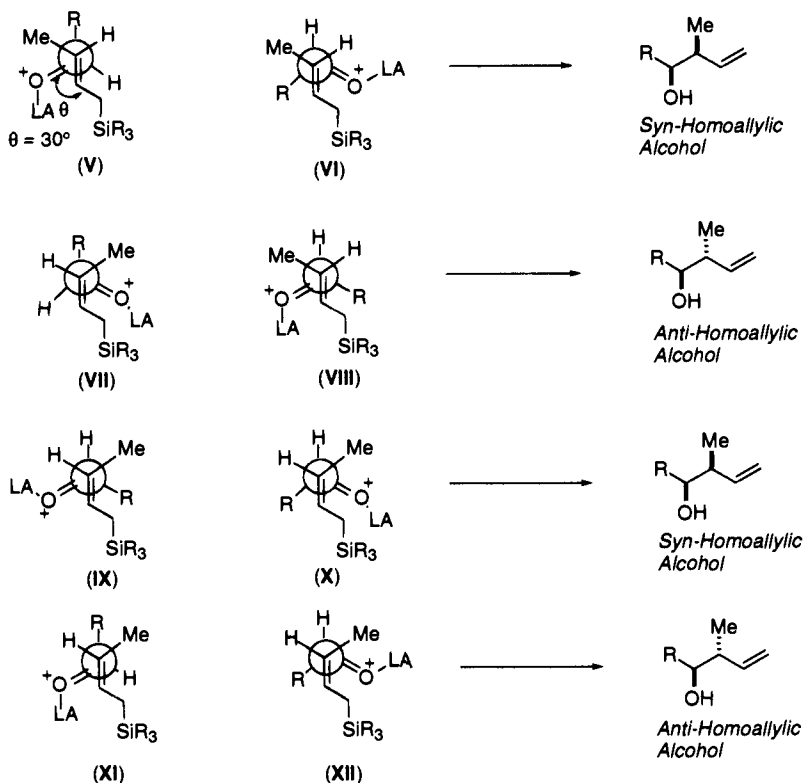

Figure 4. Synclinal transition states.

quires a synclinal orientation of the reacting double bonds where the reacting π -bonds are positioned at an angle of approximately 30° . The transition states **V** or **VI** and **IX** or **X** are favored over **VII**, **VIII**, **XI**, and **XII** because steric interactions from the Lewis acid bonded to the oxygen lone pair which is oriented *anti* to the R substituent of the aldehyde are minimized. Calculations by Houk and co-workers^{15a} have determined that the relative energy differences between the antiperiplanar and synclinal transition states are negligible. Both the antiperiplanar and synclinal models predict a *syn* selectivity for the arising chiral centers.

B. First Examples of Chiral Allylic Silanes in Acyclic Stereocontrol

Beginning in the late 1970s, a number of research groups initiated programs aimed at the investigation

and development of acyclic diastereoselective reactions employing allylmetal reagents. While the early efforts in this area focused on the development of reagents which provide useful levels of simple diastereoselection, a short time later, studies by Hayashi and co-workers^{5a,b} established that chiral (*E*)-crotyl-silane reagents (derived from an asymmetric ferrocene coupling) exhibit high levels of π -facial selectivity in addition reactions with achiral aldehydes. The silane reagents with an *E*-configuration exhibit nearly complete diastereoface selection, while the (*Z*)-silanes showed lower levels of facial bias with the aldehydes examined. For these experiments, the sense of asymmetric induction is perhaps best explained by an *anti*- S_E' mechanism using open transition states¹⁴ (Scheme 1). In this arrangement the C-Si bond is positioned *anti* to the carbonyl and coplanar to the p-orbitals of the adjacent π -bond

Scheme 1

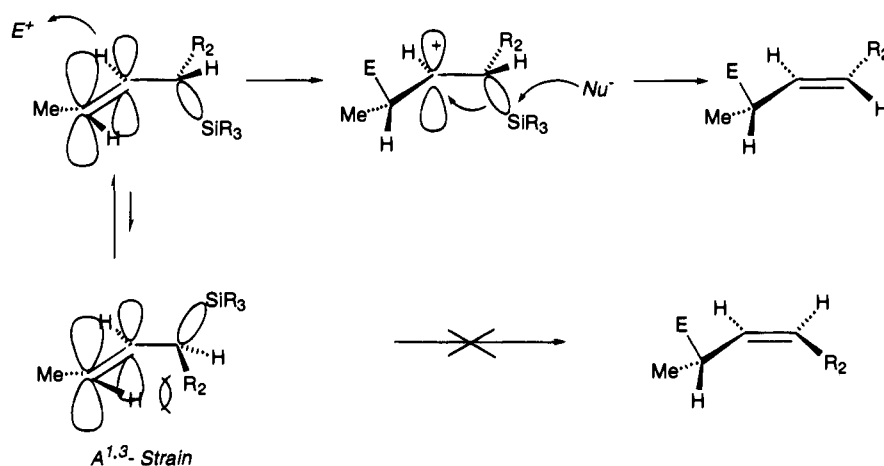
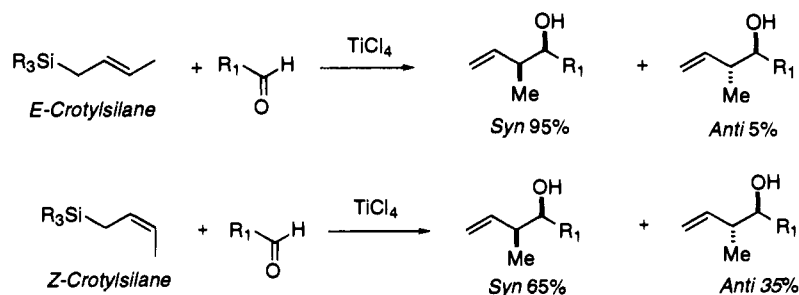
Scheme 2. Simple Diastereoselectivity with Achiral (*E*)- and (*Z*)-Crotylsilanes

Scheme 3

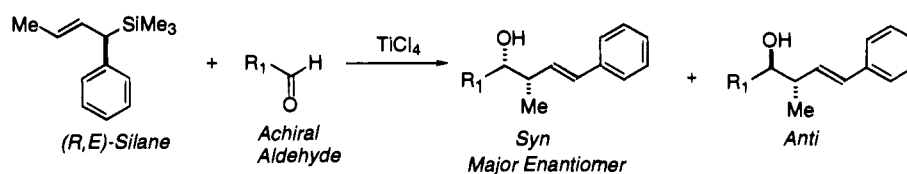

Scheme 4

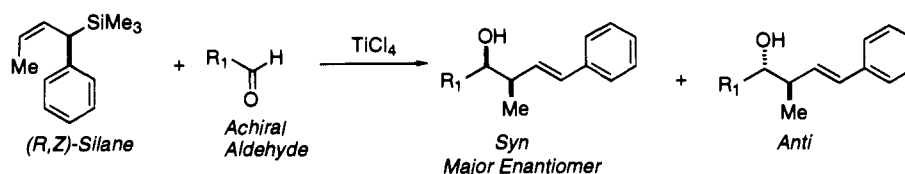

allowing stabilization of the emerging secondary carbocation.¹⁶ Generally, the (*E*)-crotylsilanes are highly selective, favoring the *syn* diastereomer (>95:5). In contrast the (*Z*)-crotylsilanes are much less selective (60–70:40–30 *syn/anti*) (Scheme 2). These reagents were successfully employed in the synthesis of enantiomerically enriched homoallylic alcohols through Lewis acid-catalyzed addition reactions of (*R,E*)- and (*R,Z*)-crotylsilanes to achiral aldehydes. Those experiments illustrate that the sense of absolute asymmetric induction is dependent on the olefin configuration (*E* or *Z*, see Schemes 3 and 4).

Table 1 summarizes the important results concerning addition reactions of optically active (*R,E*)- and (*R,Z*)-allylsilanes. The origin of the π -facial selectivity in these reactions can be traced to the usual *anti* selectivity that is observed for the S_E2' reactions of allylsilanes (Figure 2).^{3a,7a} The *syn* stereochemistry with respect to the double-bond configuration (*E* or

Table 1. Asymmetric Induction in Additions of Optically Active (*R,E*)- and (*R,Z*)-Allylsilanes to Achiral Aldehydes^{5b}

entry	allylsilane	R ₁ CHO	diastereoselection ^a		yield ^b (%)
			(<i>R,E</i>)	(<i>R,Z</i>)	
1	(<i>R,E</i>)	^t BuCHO	>99:1		47
2	(<i>R,Z</i>)	^t BuCHO		>99:1	27
3	(<i>R,E</i>)	ⁱ PrCHO	>95:5		67
4	(<i>R,Z</i>)	ⁱ PrCHO		>65:35	61

^a The ratio *syn/anti* was determined by HPLC and ¹H NMR.
^b Isolated by preparative TLC. Yields are based on the allylsilane and are not optimized.

Z) is also very high even with aldehydes bearing sterically bulky substituent groups.

Taddei and co-workers reported that chiral allyltrimethylsilanes containing an optically active ligand derived from (–)-myrtenal attached to silicon underwent enantioselective addition reactions with achiral aldehydes (Scheme 5) to give after hydrolysis with

Scheme 5

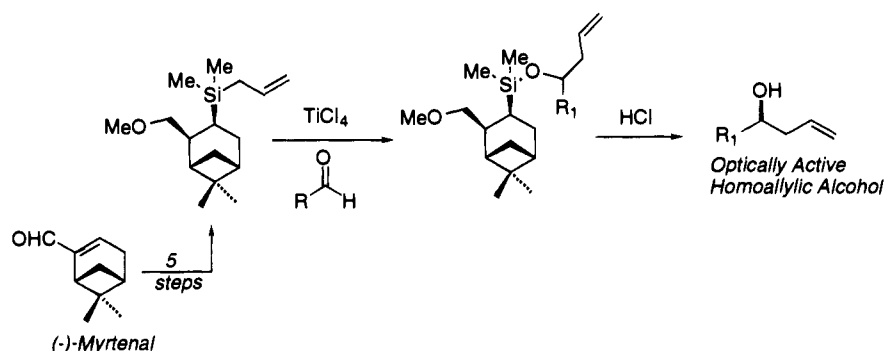

Table 2. Enantioselective Allylation of Achiral Aldehydes Catalyzed by TiCl_4 ¹⁷

Entry	Aldehyde	Homoallylic alcohol	Yield ^a	%ee ^b
1			58	46
2			61	40
3			45	21
4			39	40

^a Yields of isolated products. ^b Enantiomeric excess (ee) determined by polarimetric data and NMR analysis (Mosher's method).

HCl, optically active homoallylic alcohols.¹⁷ A variety of Lewis acids were examined in an attempt to optimize enantiomeric excess, and TiCl_4 was found to be the most effective catalyst. The important results of the TiCl_4 -promoted additions are given in Table 2.

Useful levels of stereoselectivity were obtained in condensation reactions of C3-substituted allylsilanes (crotylsilanes) to chiral aldehydes. Lewis acids that

are capable of chelating to heteroatoms have been used to direct the stereochemical course of allylsilane additions to α -alkoxy and α,β -dialkoxy carbonyl compounds. Early investigations on the additions of allylsilanes to α -alkoxy aldehydes have established high levels of *syn* stereoselection in the presence of bidentate Lewis acids such as TiCl_4 and SnCl_4 .¹⁸ In contrast, the use of monodentate Lewis acids such as $\text{BF}_3\cdot\text{OEt}_2$ (non-chelation-controlled reaction conditions) results in the formation of the *anti*-1,2-diol product.

C. Reactions with Acetals

The asymmetric crotylsilation reactions of acetals and aldehydes has been the subject of several recent reports. Research conducted in our laboratories has established the utility of chiral (*E*)-crotylsilanes of the structural type illustrated in Scheme 6 as reagents for highly diastereo- and enantioselective condensation reactions with acetals.¹⁹ The initial report concerning these reagents describes the Lewis acid-catalyzed reactions of chiral (*E*)-crotylsilanes derived by an Ireland–Claisen rearrangement with aryl acetals and documents that these reagents function as effective carbon nucleophiles in a highly stereoselective synthesis of homoallylic ethers. Specifically, the general process illustrated in Scheme 6 constitutes a one-step construction of functionalized hexenoic acid derivatives containing three stereocenters, an *E* double bond, and a terminal carbo-methoxy group. The reaction provides a remarkably simple procedure for the construction of highly functionalized hexenoic acid derivatives with a *syn* disposition between the emerging ether and methyl

Scheme 6

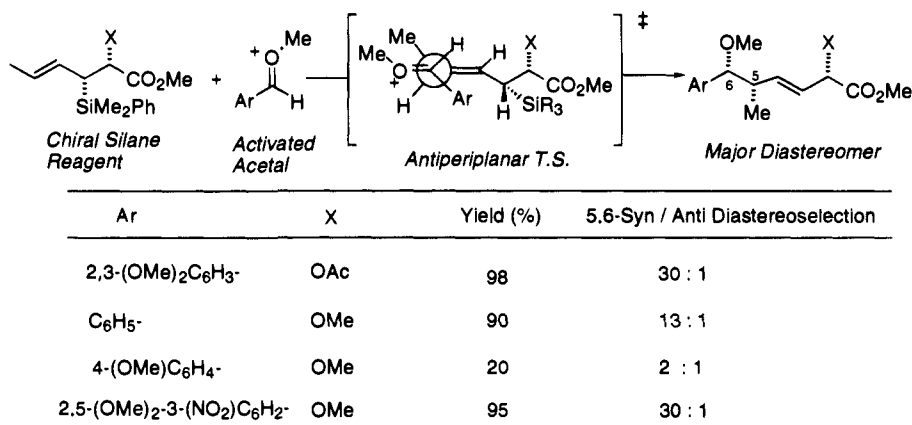

Scheme 7

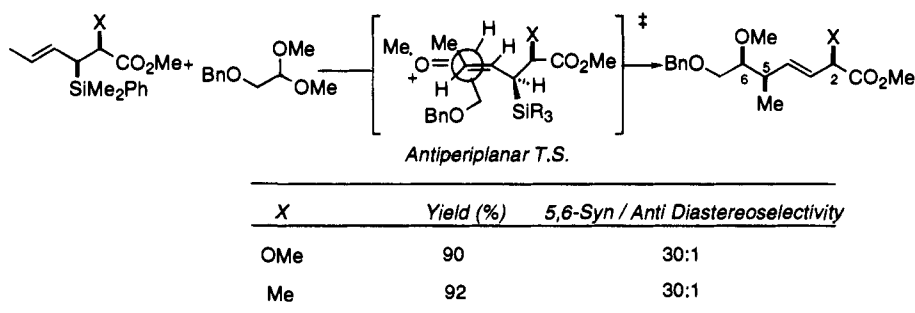

Scheme 8

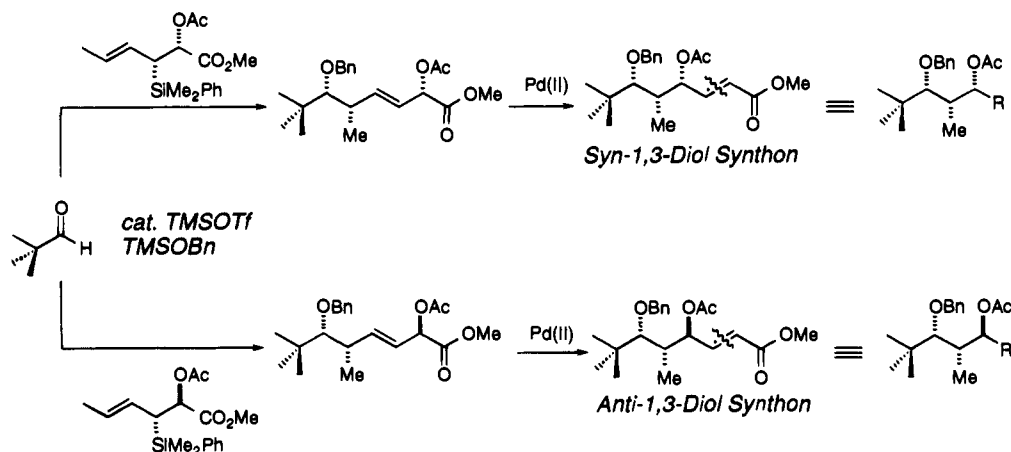

Scheme 9

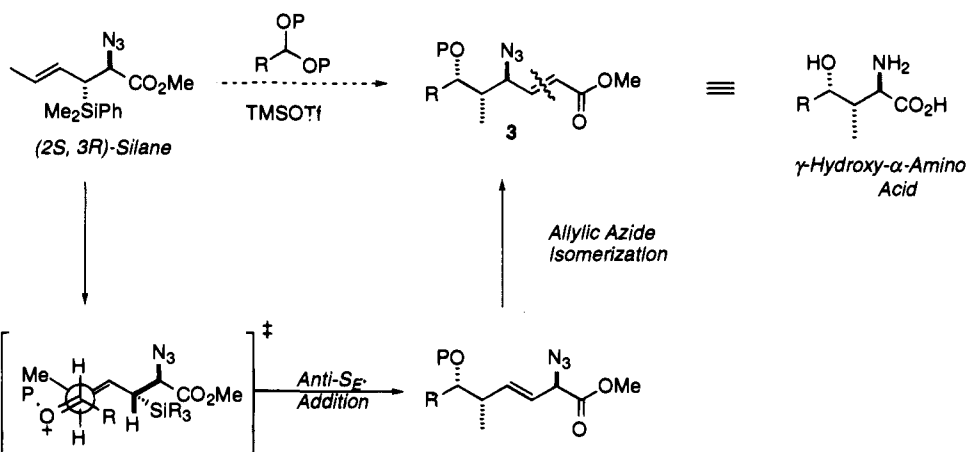

groups. The two new stereocenters (5,6-*syn*) are generated with high levels of absolute stereocontrol (95% ee). The sense of asymmetric induction results from the absolute configuration at the stereogenic center bearing the silicon group which participates in an *anti*-S_{E'} addition process. Collectively, these examples support the notion that the stereocenter bearing the C–Si bond can be used as an effective stereocontrolling element in acyclic reaction processes.

In a subsequent study, Panek and Yang have shown that the reaction of the chiral silane reagent with achiral α-alkoxy- and β-alkoxyacetals (Scheme 7) resulted in the highly diastereo- and enantioselective construction of homoallylic ethers with excellent levels of 1,4- and 1,5-remote asymmetric induction.^{19c} The sense of asymmetric induction is again controlled by the center bearing the silicon

group and accordingly can be rationalized through an *anti*-S_{E'} addition.

Additionally, *syn*- and *anti*-methyl α-acetoxy chiral (*E*)-crotylsilanes undergo highly diastereo- and enantioselective addition reactions with acetals catalyzed by the action of trimethylsilyl trifluoromethanesulfonate (TMSOTf) generating α-acetoxy-β,γ-unsaturated esters (allylic acetates). The allylic acetates undergo a transposition promoted by the dichloropalladium bisacetonitrile complex PdCl₂(MeCN)₂ generating 1,3-diol synthons (Scheme 8).²⁰

An interesting variation of the use of these chiral silane reagents involves the use of a crotylsilane bearing an α-azido ester functionality.²¹ Both the *syn* and *anti* diastereomers of (*E*)-crotylsilanes undergo highly stereoselective addition reactions with acetals catalyzed by the action of trimethylsilyl trifluoromethanesulfonate (TMSOTf) to generate α-azido-

Table 3. Stereoselective Allylic Azide Isomerization²⁰

Entry	Acetal / Aldehyde	Silane	5,6-Ratio Major Diastereomer ^a (% syn/anti)
1			
2			
3			
4			
5			

^a All yields are based on pure materials isolated by chromatography on SiO₂. Ratio of products was determined by ¹H NMR.

Scheme 10



Scheme 11



β,γ -unsaturated esters (allylic azides) with well-defined 1,4- and 1,5-stereochemical relationships. As illustrated in Scheme 9 with the (*2S,3R*)-crotylsilane, the initial condensation products undergo a facile stereoselective allylic azide isomerization generating 1,3-*anti*-azido ethers, synthetic equivalents of γ -hydroxy- α -amino acids. Related examples of the asymmetric addition/allylic acid isomerization are summarized in Table 3.

The chiral (*E*)-crotylsilanes developed in the Panek lab are prepared by various Claisen strategies from enantiomerically enriched (*R*)- and (*S,E*)-vinylsilanes.²² Relevant examples illustrating the Claisen strategies are shown in Schemes 10–12. The concerted nature of the sigmatropic rearrangements permits preservation of chirality during the bond

Scheme 12

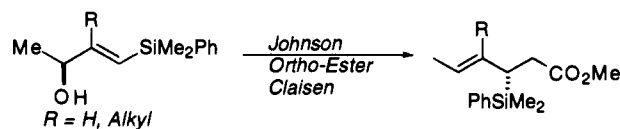

reorganization event. Therefore, by changing the configuration of the vinylsilane, the absolute chemistry of the C–Si bond can be controlled without altering the stereochemistry of the starting material. In the Ireland–Claisen examples, further diversification can be realized by controlling the stereochemistry of the enolization event.

D. Reactions with Aldehydes

In a recent report by Nishigaichi and co-workers,²³ the TiCl₄-mediated addition of the racemic allylsilane shown in Scheme 13 to achiral aldehydes results in the predominance of the 1,4-*syn* homoallylic alcohol, whereas the BF₃·OEt₂-mediated additions produces the 1,4-*anti* homoallylic alcohol (Table 4). These experiments are particularly relevant because they illustrate the fact that useful levels of remote 1,4-asymmetric induction can be realized through reaction partners which undergo bond construction through open transition states.

The turnover in diastereoselectivity is perhaps best rationalized in terms of different modes of Lewis acid chelation with the aldehyde substrate. In the case

Scheme 13

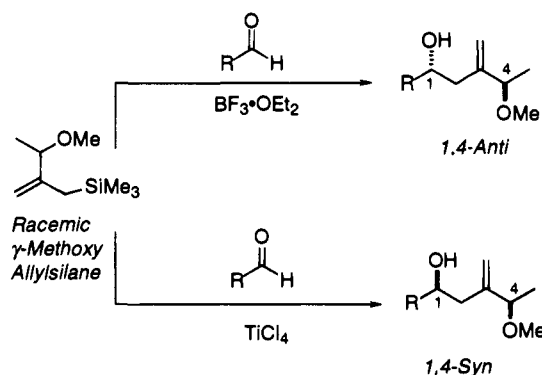

Table 4. Diastereoselective Reactions of the Racemic (γ -Methoxyallyl)silane in Eq 13²³

entry	aldehyde (R)	Lewis acid	yield homoallylic alcohol % yield; ^a syn/anti ^b
1	<i>p</i> -O ₂ NC ₆ H ₄	TiCl ₄	98; 100/0
2	<i>p</i> -O ₂ NC ₆ H ₄	BF ₃ ·OEt ₂	67; 21/79
3	<i>p</i> -MeC ₆ H ₄	TiCl ₄	24; 41/59
4	<i>p</i> -MeC ₆ H ₄	BF ₃ ·OEt ₂	35; 48/52
5	<i>n</i> -C ₇ H ₁₅	TiCl ₄	94; 100/0
6	<i>n</i> -C ₇ H ₁₅	BF ₃ ·OEt ₂	28; 29/71

^a Isolated yield. ^b *syn/anti* ratios determined by ¹H NMR.

of TiCl₄, the reaction proceeds through a bidentate chelated species (A) to give the *syn* alcohol. In the case of BF₃·OEt₂, a nonchelated monodentate species (B) is operative giving the homoallylic alcohol with an *anti* disposition between the arising stereocenters (Scheme 14).

Scheme 14

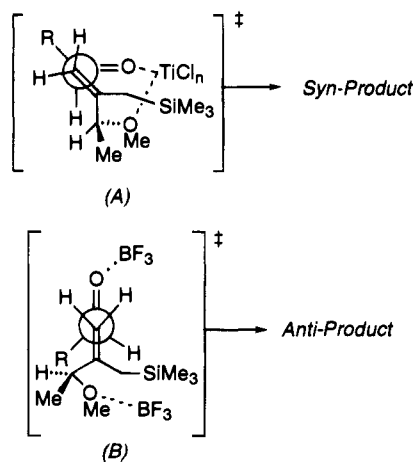

The TiCl₄-mediated addition of the racemic chiral δ -substituted (*E*)-crotylsilane with aldehydes gave the 1,3-*anti*-homoallylic alcohol as the major diastereomer with a diastereomeric excess ranging from 70% to 75%. The diastereoselectivity can be explained in terms of an antiperiplanar transition state (Scheme 15).²⁴

The effect of a silicon-bearing chiral ligand on the diastereoselectivity in additions of allylsilanes has been investigated.²⁵ The BF₃·OEt₂-mediated additions of the chiral allylsilane bearing a (-)-menthoxy ligand with alkyl-substituted aldehydes gives the homoallylic alcohols with low levels of enantioselectivity (Scheme 16).

Scheme 15

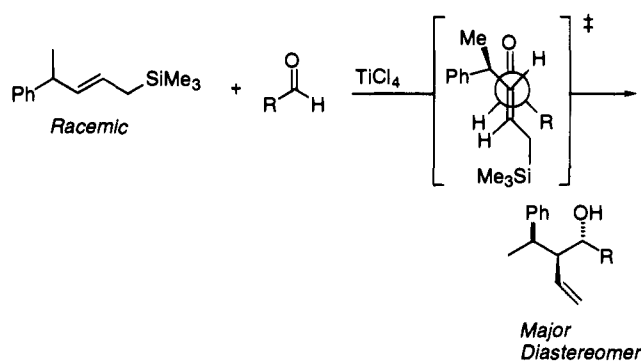

Aldehyde (R)	Yield (%)	Diastereoselection
CH ₃ -	65	69 : 23 : 6 : 2
(CH ₃) ₂ CH-	60	76 : 21 : 2 : 1

Scheme 16

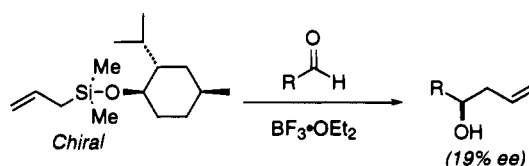

Scheme 17

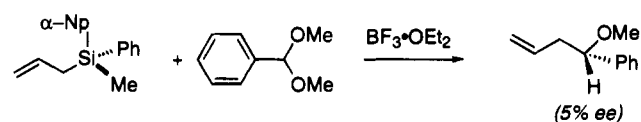

Methods for the preparation of Si-centered optically active allylsilanes have been well known since the work of Sommer and Corriu.²⁶ Although chiral silane possessing Si-centered chirality have been extensively reviewed by Chan and Wang,^{3h} a recent illustrative examples is provided here for comparative purposes. A characteristic example is the optically active α -naphthylphenylmethylallylsilane shown in Scheme 17.²⁷ However, low levels of chirality transfer have typically been observed for this chiral silane in its Lewis acid-mediated additions to aldehydes and acetals. This may be a consequence of the open transition states typical of Lewis acid-promoted allylsilane additions and/or as a result of partial racemization of the chiral silicon species.^{3f}

Fleming has reported the use of an interesting optically active heptadienylsilane reagent in a TiCl₄-promoted condensation reaction with isobutyryl aldehyde to furnish the (*R,R*)-homoallylic alcohol with good levels of asymmetric induction (Scheme 18).²⁸ The reaction proceeds through an *anti*-S_E' mode of addition as the Si-C bond is position *anti* to the activated aldehyde. In principle, both an antiperiplanar or a synclinal transition state may be used to describe the sense and levels of asymmetric induction.

A recent communication by Mikami and co-workers²⁹ demonstrated the possibility of reversing the diastereoselection in Lewis acid-mediated additions of β -substituted achiral (*E*)- and (*Z*)-crotylstannanes to 2-(benzyloxy)propanal by changing the Lewis acid from BF₃·OEt₂ (non-chelation-controlled conditions)

Scheme 18

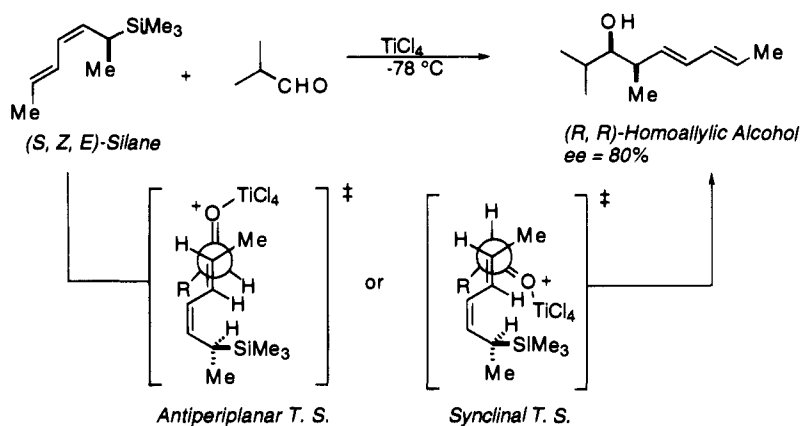

Scheme 19

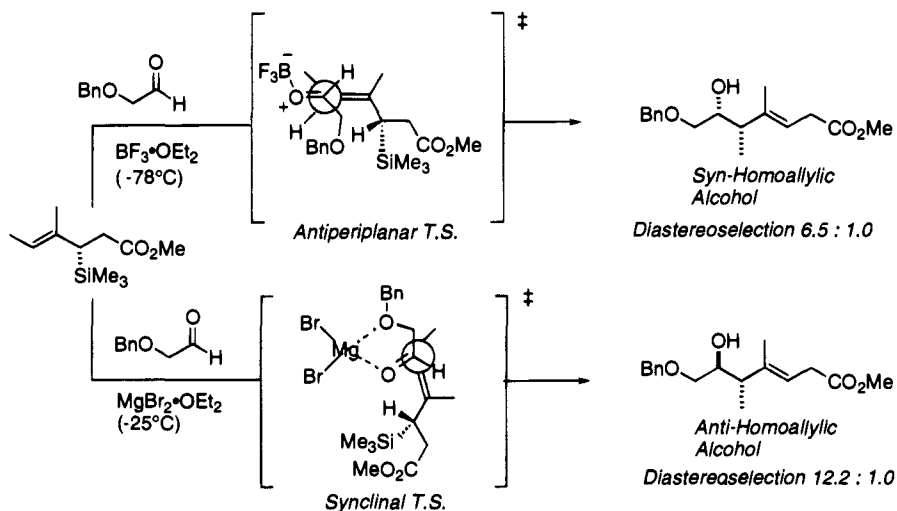

to $\text{MgBr}_2 \cdot \text{OEt}_2$ (chelation-controlled conditions). This notion has been extended to include the use of chiral (*E*)-crotylsilanes. The reactions result in the formation of *syn* or *anti* homoallylic alcohols. The same trend in the sense of diastereoselection was observed in the Lewis acid-promoted condensation reactions of chiral, β -methyl-substituted (*E*)-crotylsilanes with α -(benzyloxy)acetaldehyde (Scheme 19).³⁰ These reactions demonstrate that good levels of selectivity are reached, but with opposite stereochemical sense, in reactions catalyzed by $\text{BF}_3 \cdot \text{OEt}_2$ (nonchelation) and $\text{MgBr}_2 \cdot \text{OEt}_2$ (chelation control) generating the complimentary *syn* and *anti* homoallylic alcohols. Additionally, the enantiomeric products are readily accessible via the enantiomeric β -methyl-(*E*)-crotylsilane.

The intramolecular variant of these allylsilane additions has also been explored. A more general and comprehensive treatment of the intramolecular additions of allylsilanes has recently been published.^{3b,31} Denmark and co-workers have recently conducted a series of detailed investigations aimed at the elucidation of the mechanism for Lewis acid-promoted additions of chiral allylsilanes to acetals and aldehydes.³² These studies have focused on the cyclization of a chiral allylsilane aldehyde, shown in Scheme 20, with various Lewis acids. The model silyl aldehyde was constrained to four transition state structures having either a synclinal or antiperiplanar orientation of the reacting double

bonds and participating in a *syn*- S_{E}' or *anti*- S_{E}' addition process. The authors observed a strong preference for the *anti*- S_{E}' pathway having a synclinal or antiperiplanar orientation of the double bonds to give the (*Z*)-homoallylic alcohols.

As a result of efforts directed toward the synthesis of the cyclohexyl moiety of the immunosuppressant FK-506, the chiral allylsilane aldehyde depicted in Scheme 21 was recently prepared.³³ The $\text{BF}_3 \cdot \text{OEt}_2$ -mediated addition of the chiral allylsilane aldehyde gives a 53:47 mixture of the 1,6-*anti* and 1,6-*syn* homoallylic alcohols respectively. The stereochemical outcome of the reaction can be explained by assuming a chairlike transition-state model with an antiperiplanar or synclinal orientation of the double bond of the allylsilane functionality.

Intramolecular allylsilane additions may also be induced through anionic oxy-Cope rearrangements of 1,2-divinylcyclohexanols (Scheme 22).³⁴ The initial anionic oxy-Cope reaction generates a cyclodecenone with a *trans* orientation of the double bond. The Bu_4NF -mediated transannular reaction of the allylsilane results in the formation of the *cis*-fused hydroazulenes.

A highly enantioselective synthesis of 2-methyl-3-cyclopentenol has been reported involving a TiCl_4 -promoted internal addition of chiral (*E*)- and (*Z*)-crotylsilanes bearing a proximal aldehyde group.³⁵ The overall process is summarized in Scheme 23 where both (*R,E*)- and (*S,Z*)-silanes are shown pass-

Scheme 20

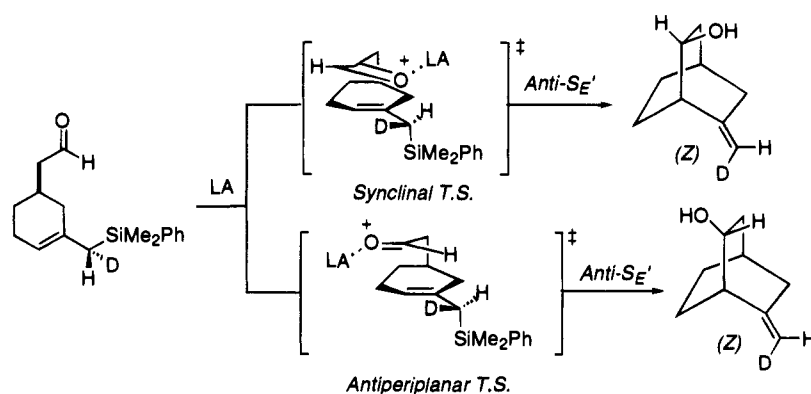

Scheme 21

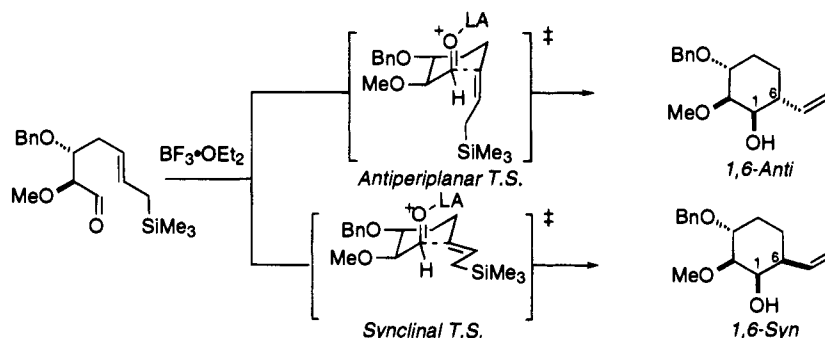

Scheme 22

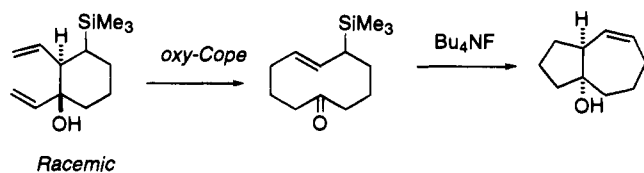

ing through antiperiplanar and synclinal transition states respectively.

E. Reactions with α,β -Unsaturated Carbonyl Compounds

Recent research conducted in our laboratory has established that our chiral β -methyl-substituted (*E*)-crotylsilanes participate in a stereoselective conjugate addition to α,β -unsaturated *N*-acyloxazolidinones with diastereoselectivities greater than 30:1 (Scheme 24).³⁶ These double stereodifferentiating reactions may provide access to synthons for the asymmetric synthesis of polypropionate-derived natural products.

Scheme 23

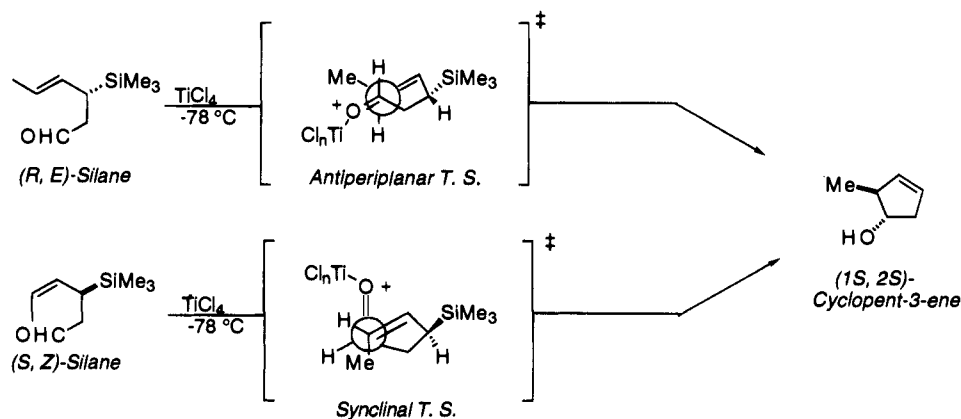

Another example of a conjugate addition of a chiral racemic allylsilane is shown in Scheme 25.³⁷ The addition of the (α -acyloxyallyl)silane may proceed through the *in situ* generation and subsequent 1,3-silyl isomerization process of a hypervalent silicon species which traps the electrophilic double bond of the cyclohexenone generating the β -substituted cyclohexanone with only modest diastereoselection. The diastereoselection may result from the lack of configurational purity (*E* or *Z*) of the isomeric γ -substituted allylsilane.

F. Reactions with Acyliminium Ions

These additions represent a well-documented area of research and a number of reviews are available which detail the development and applications of these reactions.³⁸ The $\text{BF}_3\cdot\text{OEt}_2$ -mediated condensations of chiral (*E*)-crotylsilanes with *in situ* generated achiral *N*-acylimines produce the homoallylic *N*-acylamines or tetrasubstituted *N*-acylpyrrolidines

Scheme 24

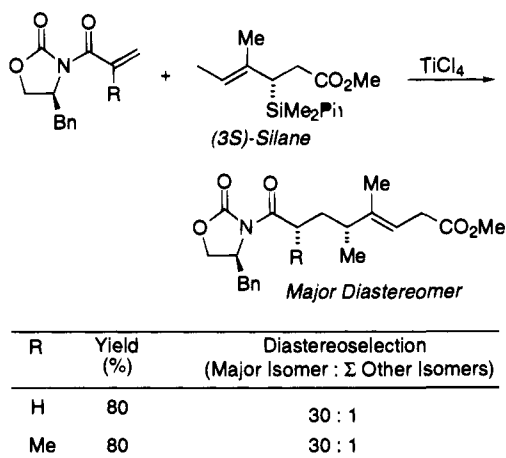

Scheme 25

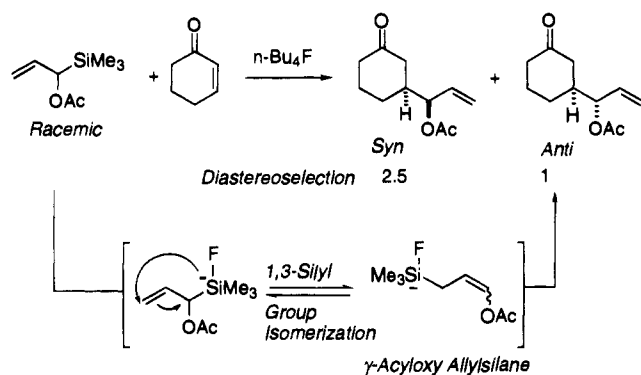

with high levels of diastereoselection (Scheme 26, Table 5).³⁹ It was found that the elimination pathway leading to the *N*-acylamines was favored at temperatures of $-20\text{ }^\circ\text{C}$, while the pyrrolidine annulation pathway was favored at temperatures lower than $-78\text{ }^\circ\text{C}$ with aryliminium species. The high levels of diastereoselection result from the ability of the silane reagent with the stereogenic center bearing the silicon group to select one enantioface of the imine.

[3 + 2]-Annulation Processes

G. Reactions with α,β -Unsaturated Carbonyl Compounds

Although beyond the context of this review, an impressive body of work has been accomplished by Knölker and co-workers concerning the use of achiral allylsilanes for the construction of cyclopentane ring systems.⁴⁰ Additional studies by Monti and co-

Scheme 26

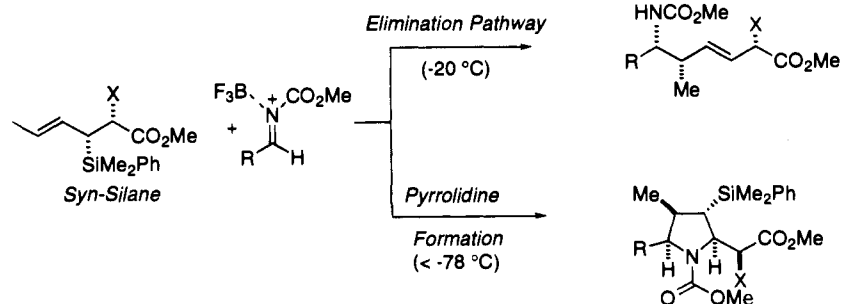
Table 5. Synthesis of Homoallylic *N*-Acylamines and *N*-Acylpyrrolidines (Eq 26)³⁹

Entry	X	Acetal Aldehyde	Major Product	% Yield; Syn / Anti ^a
1	OMe			(79%; >9 : 1) ^b
2	OMe			(72%; 20 : 1) ^c
3	OMe			(47%; 20 : 1) ^c
4	OMe			(53%; 10 : 1) ^c

^a Based on pure material isolated by chromatography. Ratios were determined by ¹H NMR. ^b Run in CH₂Cl₂ from -78 to $-20\text{ }^\circ\text{C}$, 24–32 h using BF₃·OEt₂. ^c Run in CH₂Cl₂ from -100 to $-78\text{ }^\circ\text{C}$, 12–24 h using BF₃·OEt₂.

workers have also demonstrated that achiral allylsilanes can participate in concerted [2 + 2] cycloadditions affording substituted cyclobutane derivatives provided the appropriate Lewis acid is used.⁴¹ The research of Danheiser⁴² and Panek⁴³ has established the utility of chiral allyl- and crotylsilanes as three carbon components in [3 + 2] annulations to produce substituted carbocyclic and heterocyclic ring systems with useful levels of stereoselectivity. This section will summarize those contributions which have utilized chiral silane reagents, thus providing more definitive information on the stereochemical course of the [3 + 2]-annulation reactions.

In a recent set of experiments employing racemic allylsilanes, Danheiser and co-workers have utilized chiral butenylsilane derivatives in Lewis acid-catalyzed additions to α,β -unsaturated aldehydes to produce the trisubstituted cyclopentanes (Scheme 27)

Scheme 27

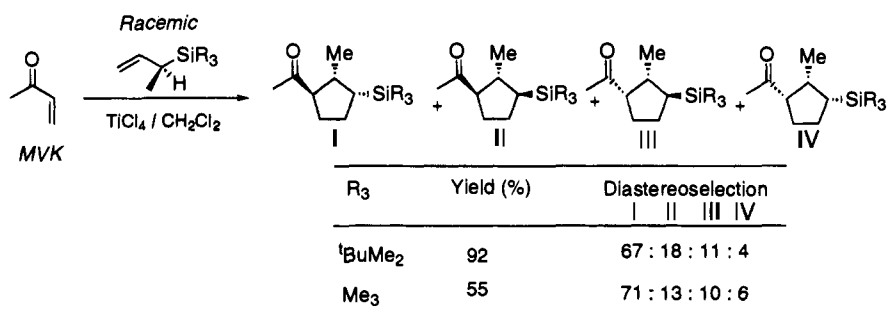

Scheme 28

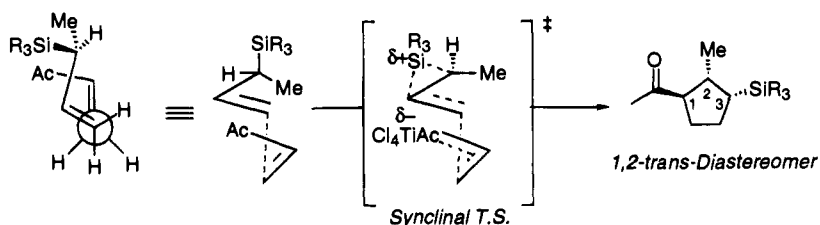

Scheme 29

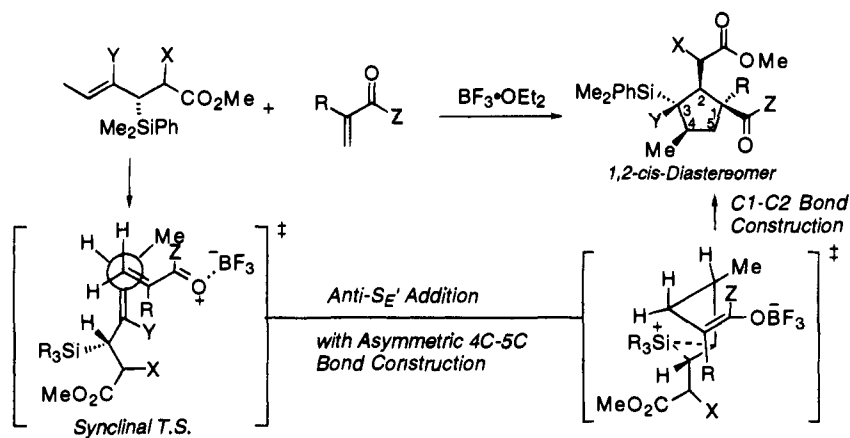

X	Y	R	Z	Yield ^a (%)	Diastereoselection ^b
H	H	H	Me	56	6 : 1
H	H	Me	H	93	>30 : 1
OMe	H	Me	H	73	>30 : 1
OMe	H	H	H	62	>30 : 1
H	Me	Me	H	65	>30 : 1

^a All yields are based on pure material isolated by chromatography.

^b Ratio of diastereomers determined by ¹H NMR.

with useful levels of stereoselectivity.^{42a} The major diastereomer formed in these reactions exhibits a *trans* orientation of the carbonyl and trialkylsilyl groups relative to the cyclopentane ring. The reaction diastereoselection has been rationalized through a synclinal transition state (Scheme 28) in which the carbonyl group of the unsaturated aldehyde is arranged in an endo orientation relative to the allyl-silane. This arrangement is thought to be favored due to the minimization of charge separation in the transition state as well as possible secondary orbital stabilization.

An asymmetric variant of the [3 + 2] cyclopentane annulation has been reported utilizing functionalized (*E*)-crotylsilanes.⁴³ These silane reagents undergo

BF₃·OEt₂-promoted conjugate addition reactions with α -substituted enals to produce tetrasubstituted cyclopentanes with high levels of diastereo- and enantioselection (Scheme 29). The accompanying table provides representative examples of the asymmetric annulation process. The use of chiral (*E*)-crotylsilanes as optically active reagents demonstrates the crucial issues of relative and internal asymmetric induction not addressed in the previous annulation studies. The reaction is believed to proceed by an initial 1,4-addition which is followed by a 1,2-silyl migration and a final cyclization step involving the derived boron enolate resulting in the construction of the cyclopentanoid product. Interestingly, the stereochemical outcome of these asymmetric cyclo-

Scheme 30

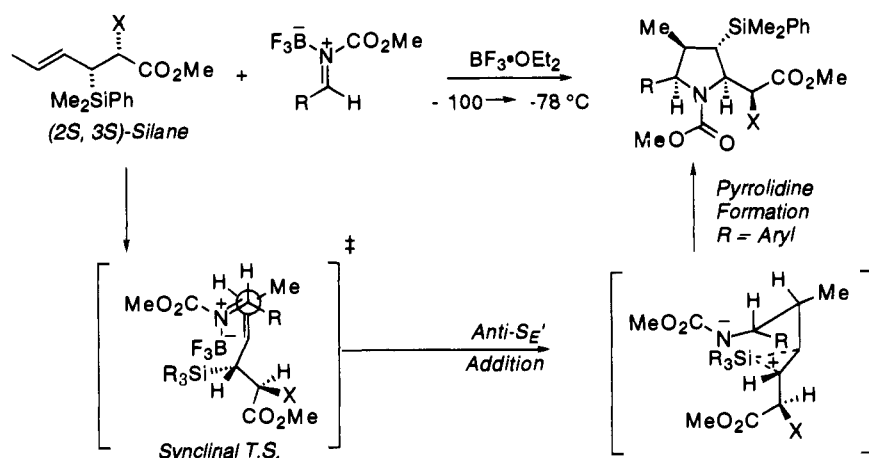

Scheme 31

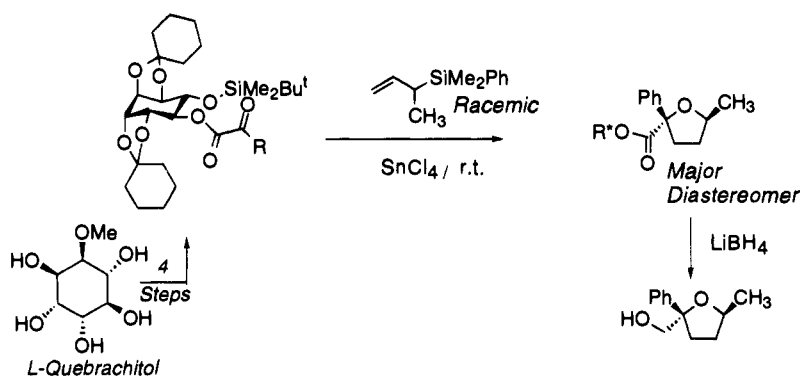

pentane annulations (1,2-*cis*) could not be rationalized using the transition-state model shown in Scheme 28 as it did not correlate with the experimentally observed stereochemistry of the cyclopentanes formed.

H. Reactions with Activated C=N π -Bonds

The $\text{BF}_3 \cdot \text{OEt}_2$ -mediated condensations of chiral (*E*)-crotylsilanes with *in situ* generated achiral *N*-acylimines to produce tetrasubstituted *N*-acylpyrrolidines described in section III.F (Scheme 26) provides an excellent example of this mode of addition.³⁹ Under $\text{BF}_3 \cdot \text{OEt}_2$ catalysis, the formation of the 2,5-*cis*-pyrrolidine is consistent with an *anti*- S_{E}' pathway through a synclinal orientation of the participating π -bonds (Scheme 30). The developing β -carbocation is illustrated rearranging through a bridging silinium ion which promotes the heterocyclization.

I. Reactions with Activated C=X π -Bonds

The synthesis of tetrahydrofurans by the cycloaddition of a chiral α -keto ester and a (α -methylallyl)silane has recently been reported by Akiyama and co-workers.⁴⁴ The L-quebrachitol derived chiral α -keto ester reacts with the silane to give the corresponding 2,5-substituted tetrahydrofuran with high levels of enantioselection (97% ee) in the single example reported. Removal of the chiral auxiliary, however, requires a LiBH_4 reduction which could limit the utility of the reaction to reductively stable 2,5-substituents (Scheme 31). The investigation also indicated that the ligands bound to the silicon had

Scheme 32

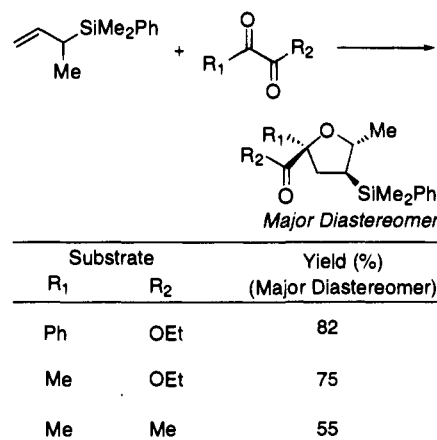

no detectable effect on the diastereoselection of the annulation in the analogous reaction using achiral allylsilanes.

Akiyama and co-workers have also described a SnCl_4 -mediated [3 + 2] annulation of a racemic butenylsilane derivative with achiral α -keto esters as well as with a 1,2-diketone.⁴⁵ The α -methyl-derived allylsilane reacts with α -keto esters as well as the biacetyl diketone (entry 3, Scheme 32) to yield the 2,2,4,5-substituted tetrahydrofuran with useful levels of diastereoselection (96% de). The accompanying table provides examples of this annulation process. The reaction diastereoselection has been rationalized via a Cram-chelate synclinal transition state model (Scheme 33).

Scheme 33

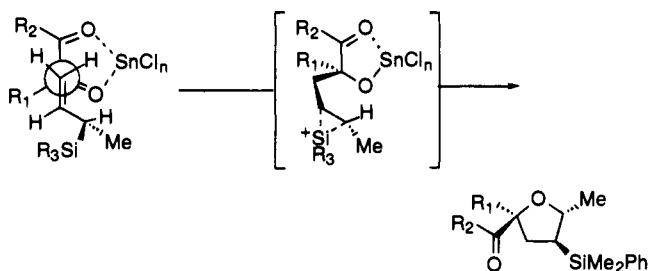

The Lewis acid-mediated additions of the chiral (*E*)-crotylsilanes to α - and β -substituted benzoyl aldehydes constitutes a simple procedure for the construction of optically pure substituted tetrahydrofurans (Scheme 34).⁴⁶ The heterocyclization produces the 2,5-*cis*-substituted tetrahydrofurans with high levels of diastereoselectivity (*de* = 94–96%). The 2,5-*cis*-stereochemistry of the tetrahydrofurans is consistent with an *anti*- S_E' mode of addition and 1,2-cationic silyl migration through a synclinal or antiperiplanar transition state.

In an example of double stereodifferentiation⁴⁷ with chiral silane reagents, it was found that the α -methyl-(*E*)-crotylsilanes undergo Lewis acid-promoted additions with (*S*)-2-(benzyloxy)propanal producing nearly enantiomerically pure tetrahydrofurans as shown in Scheme 35.⁴⁸ The diastereoface selection

is determined by the choice of Lewis acid and the absolute stereochemistry of the crotylsilane. As illustrated in Scheme 35 below, the $\text{BF}_3 \cdot \text{OEt}_2$ -promoted addition produces the *cis*-2,5-substituted tetrahydrofuran, whereas chelation-controlled conditions employing SnCl_4 afforded the diastereomeric tetrahydrofuran with the complimentary 2,5-*trans* stereochemistry. Additions to the enantiomeric silane utilizing $\text{BF}_3 \cdot \text{OEt}_2$ or SnCl_4 afforded the 2,5-*cis*-substituted furan stereochemistry in both cases.

In another example of a double stereodifferentiating addition of an allylsilane to α - and β -alkoxy aldehydes, a chiral allylsilane employing stereogenic centers at the silicon atom as well as more remote positions on the chiral auxiliary was recently reported by Jensen and co-workers.⁴⁹ The SnCl_4 -mediated addition of the chiral allylsilane prepared from (-)-10-phenylpinanediol with α - and β -alkoxy chiral aldehydes affords the homoallylic alcohols with levels of diastereoselection ranging from 92:8 for the α -alkoxy aldehyde to 100:0 for the β -alkoxy aldehyde (Scheme 36). The stereochemistry of the major diastereomer was consistent with a chelation-controlled model of asymmetric induction. The experiments indicated that the heteroatom chelation enhances the level of diastereoselection. Attempts to extend the reaction to chiral aldehydes without an α -heteroatom lead to low levels of stereoselection as internal chelation was no longer possible (entry 3).

Scheme 34

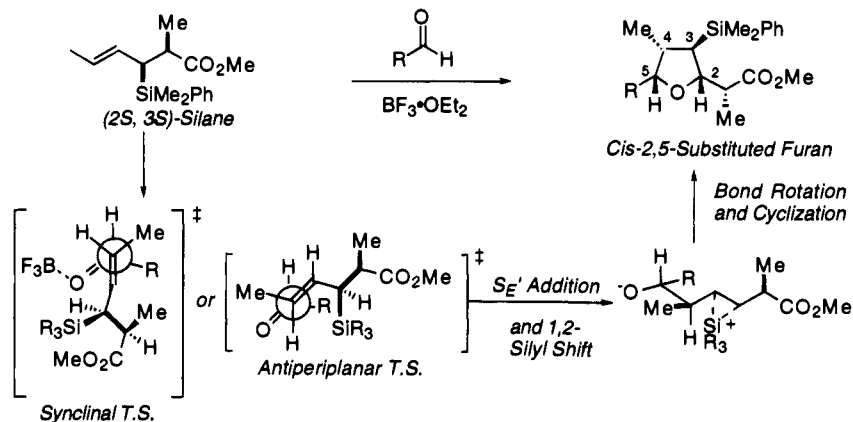

Scheme 35

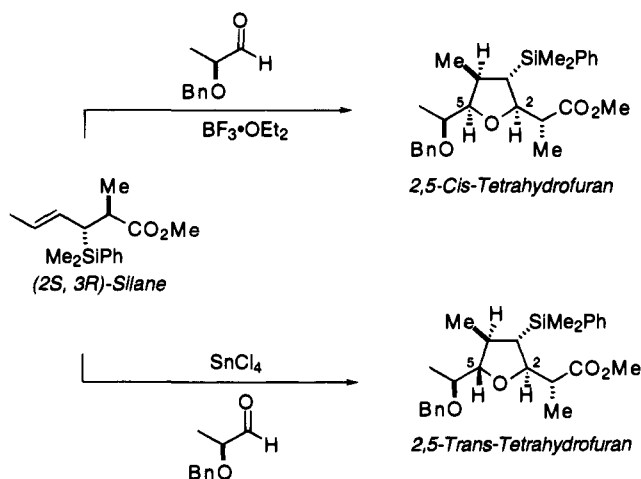

Scheme 36

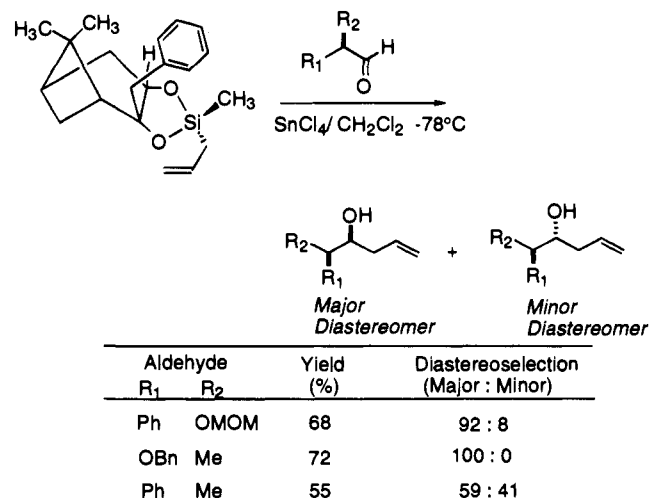

J. Reactions with Other Electrophiles

Tetrahydrofurans have also been assembled by diastereoselective cyclopropanations and epoxidations of chiral (*E*)-crotylsilanes with levels of diastereoselection reaching 30:1. The diastereoselective cyclopropanations involved a modified Simmons-Smith⁵⁰ reaction followed by acid-catalyzed rearrangement of the cyclopropane to give the tetrahydrofuran (Scheme 37). The diastereoselective epox-

Scheme 37

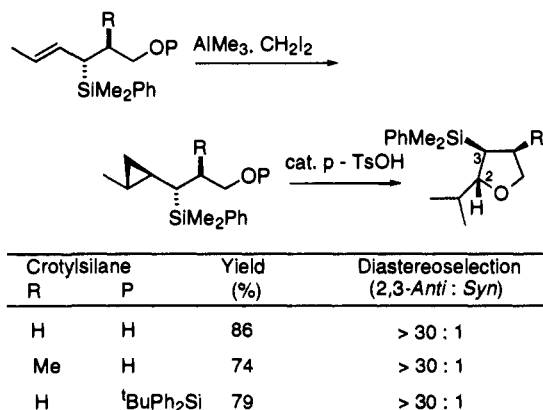

idations were promoted by *m*-CPBA⁵¹ or VO(acac)₂-TBHP⁵² and resulted in direct formation of the furan ring (Scheme 38).⁵³ The stereoselectivity of the

Scheme 38

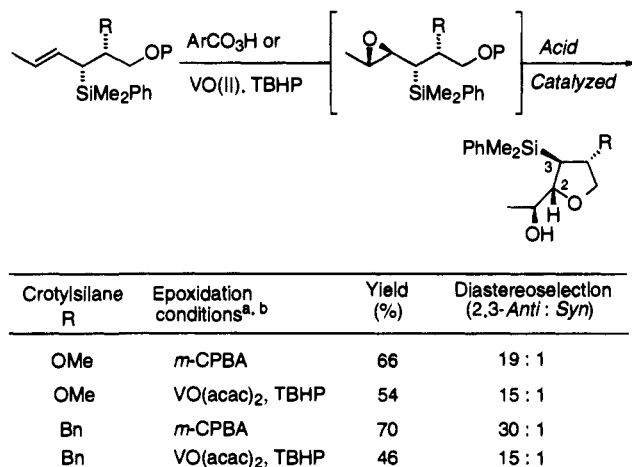

^a Reactions utilizing *m*-CPBA were run in dry benzene (18h). ^b Reactions using VO(acac)₂, TBHP were run in CH₂Cl₂ for 3h at 0 °C then 12h at r.t.

reactions results from the stereocenter bearing the silicon group directing the addition (cyclopropanation or epoxidation) to one of the π -faces of the adjacent olefin followed by a stereoselective heterocyclization.

Chiral allylsilanes have also been utilized for the synthesis of substituted lactones as shown in Scheme 39.^{54a} The catalytic osmylation of enantiomerically enriched (*E*)-crotylsilanes with homoallylic nitrogen bearing centers generates the silyl functionalized *trans*-2,5-substituted γ -lactones with high levels of diastereoselection. The lactone formation results from the diastereoselective formation of the vicinal

Scheme 39

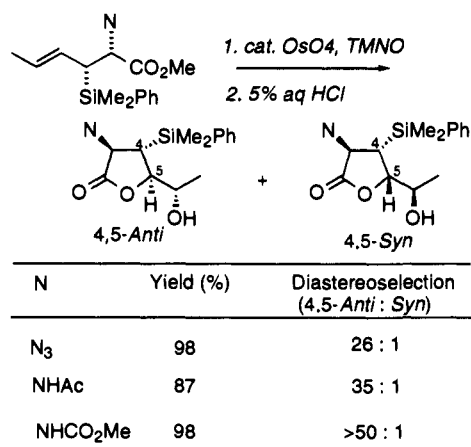

diol which readily cyclizes in the presence of acid to the γ -lactone. The observed stereochemistry is explained by the preference for osmylation *anti* to the dimethylphenylsilyl group (Scheme 40). Proctor and

Scheme 40

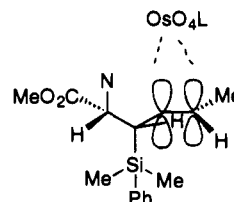

co-workers have utilized diastereoselective epoxidations of chiral crotylsilanes to produce γ -lactones (Scheme 41).^{54b} The major diastereomeric epoxide

Scheme 41

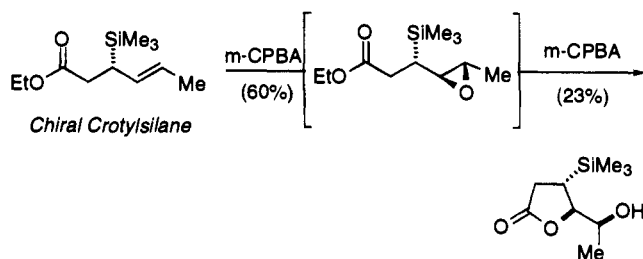

could be isolated and cyclized to the lactone under acid catalysis. However, the lactones were isolated in low yields (23–26%).

Chiral allylsilanes have also found use in the assembly of more complex heterocyclic systems. A representative example of this type of cyclization involves the addition of (*E*)-crotylsilanes to nitrosium tetrafluoroborate (NO⁺BF₄⁻) (Scheme 42). This reaction proceeds under mild conditions (–80 °C to room temperature) to yield the 3,5-substituted Δ^2 -isoxazolines.⁵⁵ The silane reagents were found to exert high levels of diastereoselectivity producing the Δ^2 -isoxazolines with ee and de values reaching 96% and 95% respectively. The synthon equivalency of these isoxazoles to β -hydroxy ketones and amino alcohols is shown in the sequence of reductive transformations illustrated in Scheme 43.

Scheme 42

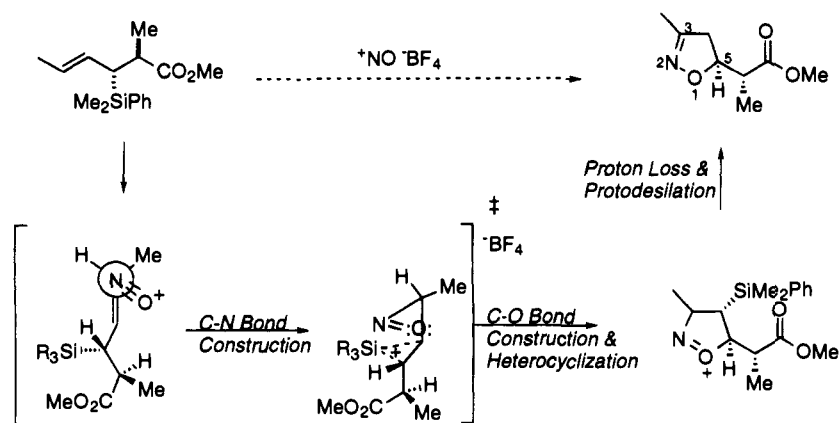

Scheme 43

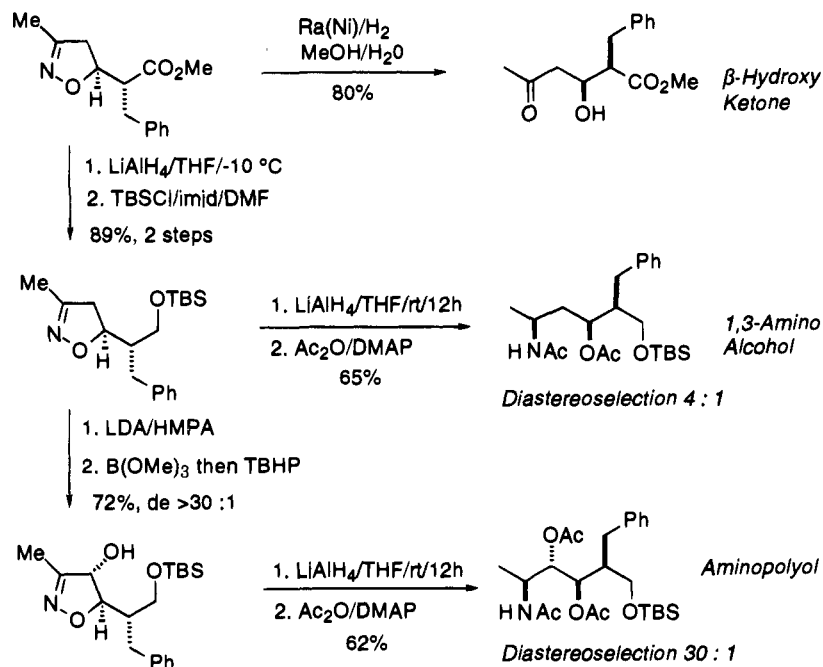

Scheme 44

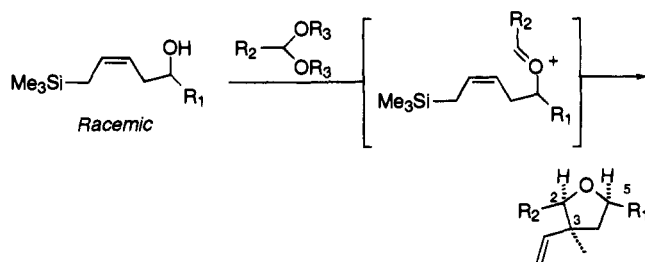

R_1	R_2	R_3	Yield ^a (%)
CH_2Ph	Ph	Me	95
CH_2Ph	Et	Et	83
CH_2Ph	$\text{HC}\equiv\text{C}$	Et	59
$\text{CH}_2\text{CO}_2^i\text{Pr}$	$\text{CH}_2=\text{CH}$	Me	85
CH_2Cl	Et	Et	66

^a Yields based on chromatographically pure products contaminated with <5% of the other 3 isomers.

Scheme 45

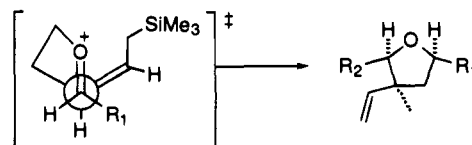

A fascinating example of a Brønsted acid-catalyzed [3 + 2] annulation of chiral racemic allylsilanes to acetals has recently been reported by Mohr.⁵⁶ The reaction relies upon the addition of the allylsilane to an oxocarbenium ion generated by transacetalization and acid-catalyzed ionization of the acetal. The tandem transacetalization–intramolecular additions give the *cis*-2,3,5-trisubstituted tetrahydrofurans in fair to good yields (Scheme 44). The success of the reaction appears to result from the fact that the transacetalization and subsequent annulation is fast compared to intermolecular addition or protodesilylation of the allylsilanes. The stereochemical results of the reaction can be rationalized via a synclinal transition state model (Scheme 45).

IV. Silicon Bonded to a Participating π -Bond

Chiral Allenylsilanes—Acyclic Diastereoselective Reactions

Acetylenic intermediates serve as important functional groups in organic synthesis and many important reactions exploiting the unique and versatile chemistry of the carbon-carbon triple bond have been devised over the last few years.⁵⁷ A general strategy for the synthesis of substituted alkynes involves substitution and addition reactions of propargylic anion equivalents. This approach is particularly well suited for the preparation of homopropargylic alcohols (Schemes 46 and 47).

Scheme 46

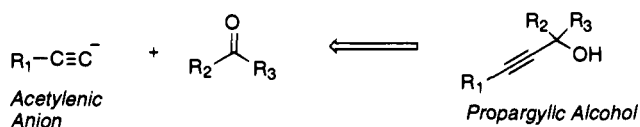

Scheme 47

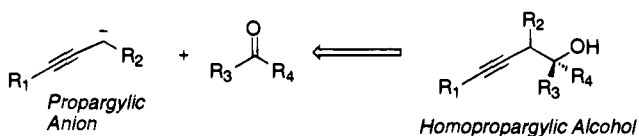

This methodology has been limited by the tendency of the metalated propargylic anions to add to electrophiles to produce a mixture of regioisomers. The lack of regiochemical control results from the fact that these anions exist as an equilibrating mixture of allenic and propargylic anions which can both add to electrophiles to produce allenic and homopropargylic alcohols (Scheme 48). Thus, product ratios are

Scheme 48

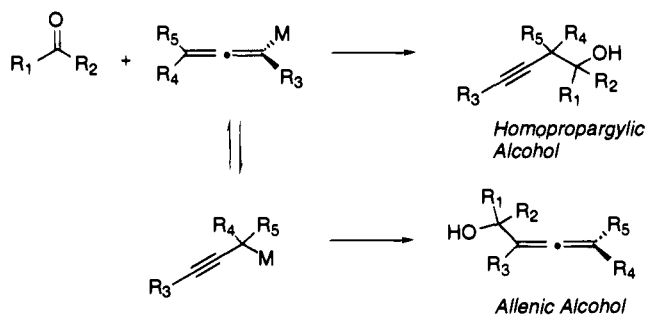

determined by the position of the equilibrium between the two organometallic species. Pioneering work by Danheiser and co-workers has resulted in the development of allenylsilanes as useful propargylic anion equivalents.⁵⁸ Importantly, these readily available organometallic compounds do not participate in the dynamic equilibrium described above and as a result undergo additions with virtual regioselectivity. As described in the following pages allenylsilanes have proven to be useful carbon nucleophiles and are known to participate in regio- and stereocontrolled addition reactions with a variety of electrophiles. Once again, in keeping within the context of this review we have selected examples involving chiral allenylsilane reagents. However, extensive

work has been accomplished utilizing achiral allenylsilanes⁵⁹ and both chiral and achiral allenylstannane.⁶⁰

A. Reactions with Aldehydes and Ketones

The $TiCl_4$ -mediated addition of allenylsilanes to aldehydes and ketones provides a general, regiocontrolled route to a wide variety of substituted homopropargylic alcohols (Scheme 49).^{59a}

Scheme 49

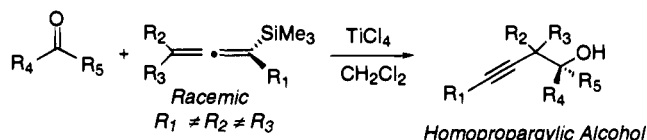

Reactions of chiral substituted allenes proceed with a preference for the formation of the *syn* diastereomer as a consequence of the *anti*- S_E2' mode of addition. The *anti*- S_E2' mode of allenylsilane additions has recently been unambiguously determined by Fleming and co-workers.^{59b} The stereochemical outcome of these reactions can be rationalized by invoking an open transition state for the addition reactions (Scheme 50) which involves an antiperiplanar orien-

Scheme 50

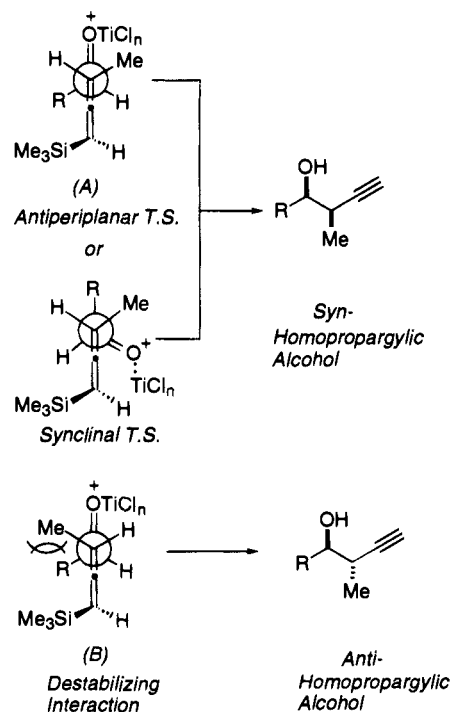

tation of the chiral allenylsilane relative to the aldehyde carbonyl. This model relies on the steric repulsion between the allenyl methyl and the aldehyde substituent as the feature most likely responsible for the destabilization of transition state **B** which leads to the *anti* (minor) stereoisomer. This destabilizing interaction is minimized in transition state **A** which is shown in two energetically equivalent arrangements (antiperiplanar or synclinal). Table 6 illustrates representative examples and summarizes the scope of the regiocontrolled synthesis of

Table 6. Regiocontrolled Synthesis of Homopropargylic Alcohols (Eq 48)⁵⁸

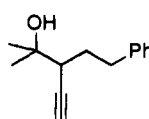
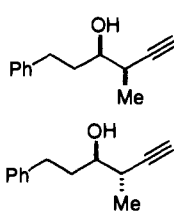
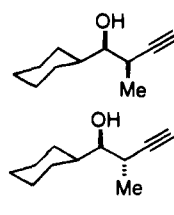
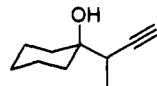
Entry	Carbonyl Compound	Allenylsilane R_1 R_2 R_3			Product(s)	Yield, Diastereoselection %; (Syn:Anti)
1	MeCOMe	H	(CH ₂) ₂ Ph	H		38
2	PhCH ₂ CH ₂ CHO	H	H	Me		89 (3.1 : 1)
3	C ₆ H ₁₁ CHO	H	H	Me		81 (4.1 : 1)
4	Cyclohexanone	H	H	Me		77

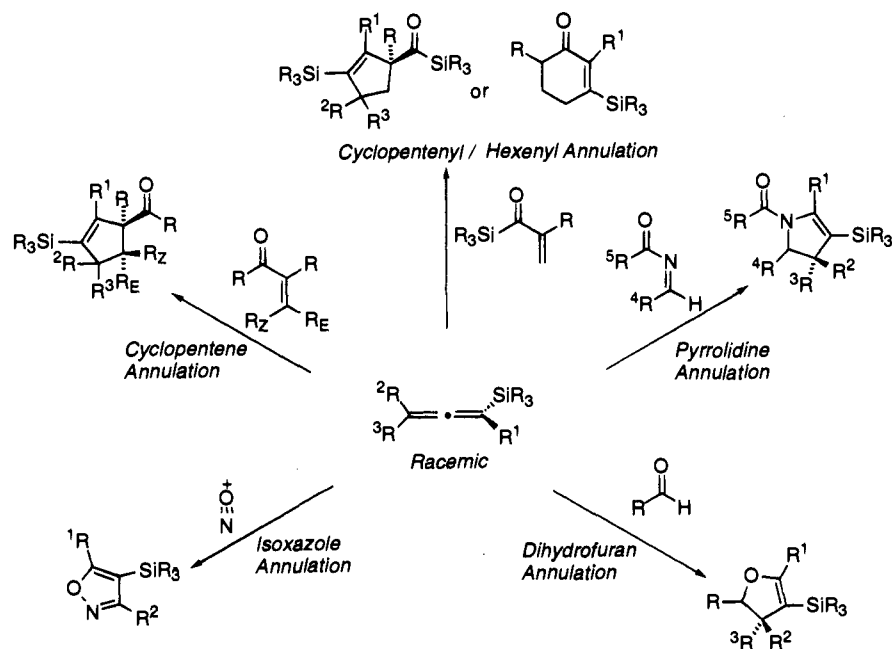
Scheme 51

homopropargylic alcohols through the use of chiral racemic allenylsilanes.

[3 + 2]-Annulation Processes

[3 + 2]-Annulation tactics involving allenylsilanes as the three-carbon component have been extensively investigated by Danheiser and co-workers.⁶¹ Their efforts in this area have resulted in the generation

of an effective strategy for the preparation of both carbocyclic and heterocyclic compounds. These processes are summarized in Scheme 51. The allenylsilane reacts with α,β -unsaturated carbonyl compounds to give the carbocyclic derivatives. Allenylsilanes react with heteroallenophiles *e.g.* aldehydes, acylium, acyliminium, iminium, and nitronium ions to yield the corresponding heterocyclic products.

Table 7. (Trimethylsilyl)cyclopentene Annulations of Chiral Allenylsilanes (Eq 50)⁶¹

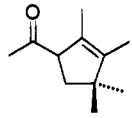
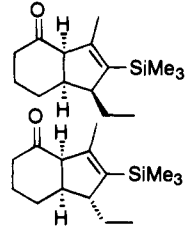
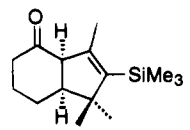
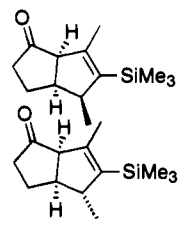
Entry	α,β -Unsaturated Ketone	Allenylsilane			Cyclopentene Product(s)	% Yield (Diastereoselection)
		R ₁	R ₂	R ₃		
1	Methyl vinyl ketone	H	H	Me		80
2	Cyclohexenone	Me	Et	H		79 (95 : 5)
3	Cyclohexenone	Me	Me	Me		61-63
4	Cyclopentenone	Me	Me	H		68 (75 : 25)

Sections B–D offer a detailed discussion of these topics.

B. Reactions with α,β -Unsaturated Carbonyl Compounds

The reaction of allenylsilanes with electron-deficient π -systems constitutes a powerful and general method for the regio- and stereoselective preparation of substituted cyclopentenes.⁶¹ As first reported, (trimethylsilyl)allenes function as three-carbon nucleophiles in TiCl₄-promoted (trimethyl)silylcyclopentene annulations (Scheme 52). The annulation pro-

Scheme 52

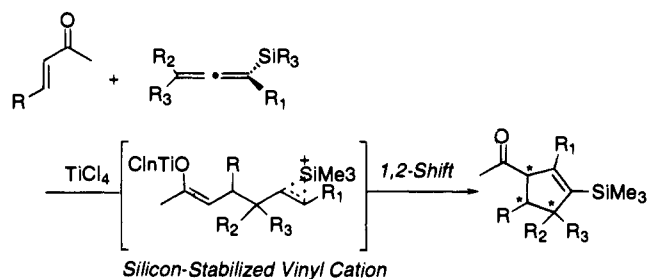

cess involves the polarization of an α,β -unsaturated carbonyl compound by TiCl₄ to generate an alkoxy allylic cation. Regiospecific electrophilic substitution of this cation at C3 of the allenylsilane produces a silicon-stabilized vinyl cation. A 1,2-shift of the trimethylsilyl group then yields an isomeric vinyl cation which is trapped by the titanium enolate to generate the annulated (trimethylsilyl)cyclopentene products.

Both cyclic and acyclic enone systems participate in the (trimethyl)silylcyclopentene annulation (Table 7). The intermediates derived from cyclohexenone and cyclopentenone cyclize to yield the 6,5- and 5,5-fused ring systems.⁶¹

α,β -Unsaturated acylsilanes serve as highly reactive carboxylic acid equivalents in conjugate addition reactions with allenylsilanes.⁵⁹ The trimethylsilyl acylsilanes provide the basis for a [3 + 3] annulation approach to six-membered carbocycles. By manipulating the trialkylsilyl group of the acylsilane the course of the annulation reaction can be controlled to produce either five- or six-membered rings (Schemes 51 and 53). The α,β -unsaturated acylsilanes combine

Scheme 53

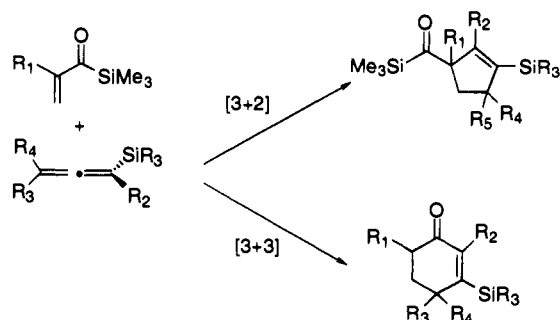

with allenylsilanes at $-78\text{ }^\circ\text{C}$ in the presence of TiCl₄ to produce the trimethylsilyl-cyclopentene annulation products in good yield.

Scheme 54

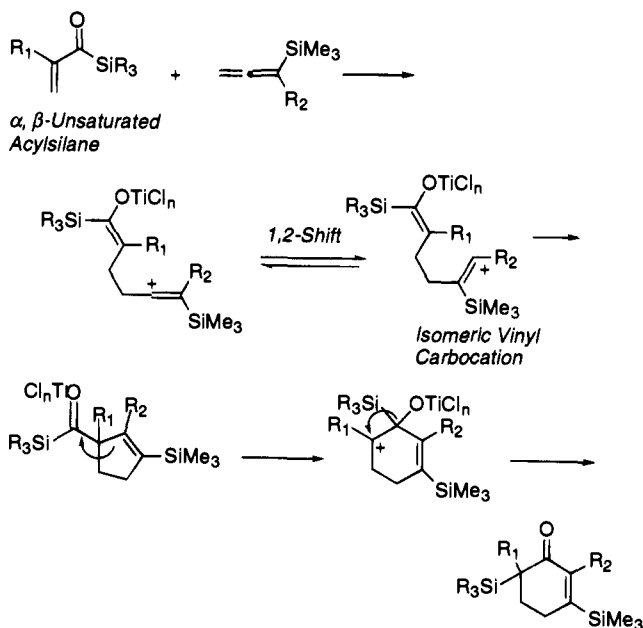

The annulation products derived from 2-alkyl-substituted α, β -unsaturated acylsilanes undergo a rearrangement to β -silylcyclohexenone derivatives when treated with TiCl_4 . The proposed mechanism is illustrated in Scheme 54.⁵⁹ The annulation process commences with the regioselective electrophilic substitution at the C3-position of the allenylsilane producing a vinyl carbocation which undergoes a 1,2-cationic trimethylsilyl shift to yield an isomeric vinyl carbocation. Cyclization then gives the [3 + 2]-annulation product. Ring expansion of the cyclopentene next generates the tertiary carbocation which undergoes a second 1,2-anionic trimethylsilyl shift to produce the cyclohexenone. Modest levels of simple diastereoselection are generally observed in these annulations.

C. Reactions with Aldehydes

A variety of aldehydes can function as heteroallenophiles in this [3 + 2] annulation (Scheme 51 and

Table 8. Preparation of Oxygen Heterocycles via [3 + 2] Annulations of Chiral Allenylsilanes⁸²

Entry	Allenophile	Allenylsilane	Annulation Product(s) <i>cis</i> / <i>trans</i> ratio	Yield (%)
1				97
2	$t\text{BuCHO}$			92
3				88

Table 8). Reactions of the C3-substituted allenylsilanes gave predominantly the *cis*-substituted dihydrofurans. The *cis* stereochemistry was anticipated on the basis of the well-documented stereochemical course of Lewis acid-catalyzed additions of 3-substituted allylsilanes to aldehydes.⁶²

D. Reactions with Activated C=N π -Bonds

The reactions of sterically encumbered allenylsilanes with *N*-acyliminium ions generated by the action of titanium tetrachloride on the γ -ethoxypyrrolidinone produced a nearly 1:1 mixture of bicyclic lactams as summarized in Scheme 55. In this

Scheme 55

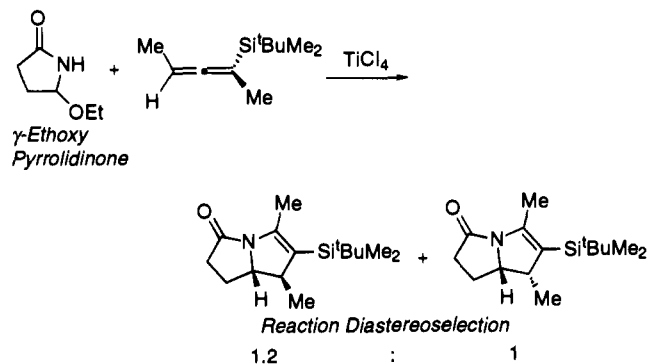

reaction it is likely the lactam product is being generated by a pathway similar to that involved in the [3 + 2] cyclopentene annulation.⁶² Thus, a regioselective electrophilic substitution of the *N*-acyliminium ion derived from substitution at the C3 position of the allenylsilane produces a vinyl cation stabilized by the hyperconjugative interaction of the adjacent σ -donor silicon group. A 1,2-cationic silicon shift then occurs affording an isomeric vinyl cation, which is trapped by the proximal nitrogen atom to form the lactam.

V. Pentacoordinate Allylsilanes

Silicon is capable of expanding its valence from the normal tetravalent silane to form pentavalent and

Scheme 56

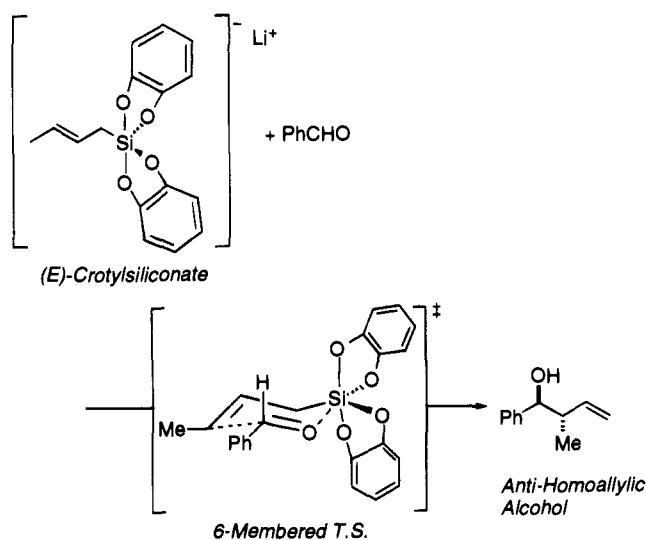

Scheme 57

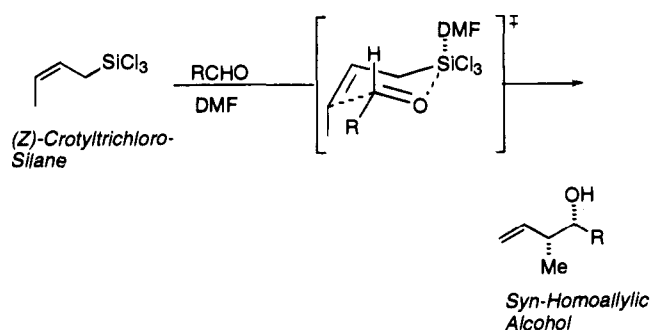

Scheme 58

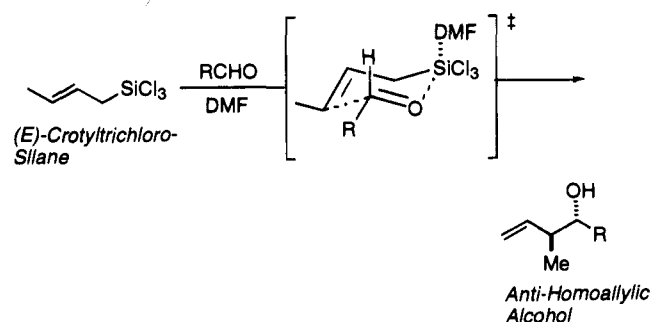

hexavalent silicate species if the silicon atom bears electronegative ligands. The pentavalent silicon spe-

Scheme 59

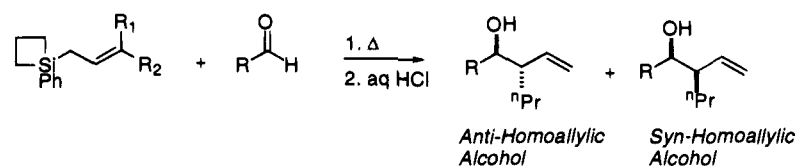

Silacyclobutane	Aldehyde	Temp / Time	Yield	Diastereoselection
R ₁ R ₂	R	(°C) (h)	(%)	Anti : Syn
H ⁿ Pr	Ph	130 24	68	95 : 5
H ⁿ Pr	ⁿ C ₆ H ₁₃	160 48	59	90 : 10
ⁿ Pr H	Ph	130 24	66	5 : 95
ⁿ Pr H	ⁿ C ₆ H ₁₃	160 48	60	20 : 80

cies bear a negative charge which is stabilized by delocalization into the electronegative ligands. As a result of the delocalization, the silicon atom becomes electron deficient and develops a significant amount of Lewis acid character.⁶³ The silicon atom can therefore serve as an organizational node in the allylations of aldehydes. The pentacoordinated allylsilicates react with aldehydes without the need for Lewis acid catalysis or fluoride ion activation. The (*Z*)- and (*E*)-allylic silicates yield the *syn*- and *anti*-homoallylic alcohols, respectively.⁶⁴ The stereochemical outcome of the addition results from a six-membered transition state and is contrary to the stereochemistry observed with Lewis acid-mediated additions of tetracoordinated allylsilanes discussed in the preceding sections of this review. The allylation reaction can be carried out with preformed allylsilicates or through the *in situ* generation of the allylsilicate.

Pentacoordinate lithium bis(catecholato)allylsilicates are synthesized by reaction of the corresponding allyltrichlorosilane with dilithium catecholate.⁶⁵ The crotylsilicate shown in Scheme 56 reacts with benzaldehyde via a six-membered transition state to afford the *anti*-homoallylic alcohol. In principle, the use of a chiral diol ligand should provide the necessary chiral environment to produce enantioface differentiation.

Recently, Kobayashi and Nishio have reported a method for the *in situ* generation of allylsilicates from allyltrichlorosilanes by coordination with DMF solvent in the allylation reaction.⁶⁶ The direct coordination of the DMF to the silicon atom to form the organosilicate was supported by ²⁹Si NMR. The resulting hypervalent silicates react with alkyl and aryl aldehydes to afford the homoallylic alcohols with useful levels of regio- and diastereoselectivity. The sense of diastereoselectivity in the allylations is explained by six-membered transition states common to silicate species (Schemes 57 and 58).

Lewis acidity may also be induced by strain at the silicon center. A recent report by Utimoto and co-workers has established Lewis acidity of silacyclobutanes.⁶⁷ The addition of (*E*)- and (*Z*)-1-(2-alkenyl)-silacyclobutanes to alkyl and aryl aldehydes proceeds without a catalyst to give the *anti*- and *syn*-homoallylic alcohols with useful levels of diastereoselectivity (Scheme 59). The diastereoselection is rationalized by a six-membered transition state model in which

Scheme 60

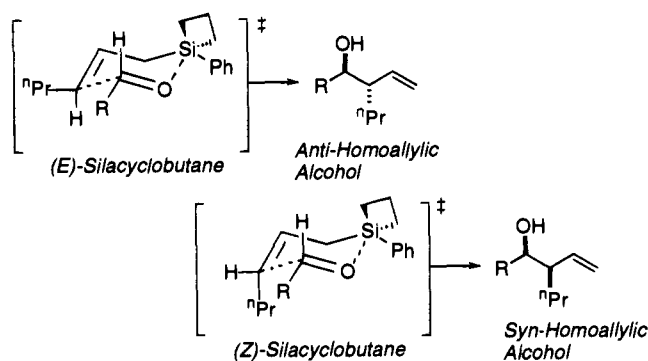

the silacyclobutane coordinates the aldehyde substrate (Scheme 60).

VI. Summary

The examples presented in this review demonstrate the utility of chiral silicon reagents in a wide range of transformations which have considerable usefulness in organic chemistry. Clearly, reagents bearing a stereogenic C–Si moiety are capable of providing high levels of diastereoselectivity and in many instances enantioface selectivity. As a result, many of the reagents discovered have been excellent candidates for reactions processes that result in high levels of relative and absolute acyclic stereocontrol and unique [3 + 2] annulation processes. The continued progress in the development of chiral silane reagents that are capable of providing high levels of enantiotopic face selectivity as well as the refinement of mechanistic interpretations of these transformations will continue to enhance their utility in organic synthesis.

VII. Acknowledgments

Support has been provided to J.S.P. by the National Institutes of Health. C.E.M. acknowledges support from a Boston University Presidential University Fellowship.

VIII. References and Notes

- Reviews on allylmetal chemistry: (a) Hoffmann, R. W. *Angew. Chem., Int. Ed. Engl.* **1982**, *21*, 555. (b) Yamamoto, Y.; Maruyama, K. *Heterocycles* **1982**, *18*, 357. For detailed reports on the use of chiral crotylboronates in addition reactions to aldehydes, see: (c) Roush, W. R. In *Comprehensive Organic Synthesis*; Heathcock, C. H., Ed.; Pergamon: Oxford, 1990; Vol. 2, p 1. (d) Hoffmann, R. W. *Pure Appl. Chem.* **1988**, *60*, 123 and references cited therein.
- (a) Evans, D. A. *Aldrichchimica Acta* **1982**, *15*, 23. (b) Evans, D. A.; Takacs, J. M.; McGee, M. D.; Ennis, D. J.; Mather, D. J.; Bartoli, J. L. *Pure Appl. Chem.* **1981**, *53*, 1109. (c) Evans, D. A.; Nelson, J. V.; Taber, T. R. *Top. Stereochem.* **1982**, *13*, 1.
- For recent reviews in the chemistry of allylsilanes see: (a) Fleming, I. *Org. React.* **1989**, *37*, 57. (b) Majetich, G. In *Organic Synthesis: Theory and Application*; 1989; Vol. 1, p 173. (c) Birkover, L.; Stuhl, O. In *The Chemistry of Organic Silicon Compounds*; Patai, S., Rappoport, Z., Eds.; Wiley: New York, 1989; Chapter 10. (d) Sakurai, H. *Pure Appl. Chem.* **1982**, *54*, 1. (e) Yamamoto, Y.; Asao, N. *Chem. Rev.* **1993**, *93*, 2239. (f) Fleming, I. In *Comprehensive Organic Chemistry*; Barton, D. H. R., Ollis, W. D., Eds.; Pergamon Press: Oxford, 1979; Vol. 3, p 539. (g) Sarkar, T. K. *Synthesis* **1990**, 969. (h) Chan, T. H.; Wang, D. *Chem. Rev.* **1992**, *92*, 995.
- Hayashi, T.; Konishi, M.; Fukushima, M.; Mise, T.; Hagotani, M.; Tajika, M.; Kumada, M. *J. Am. Chem. Soc.* **1982**, *104*, 180. See also ref 20.
- Hayashi, T.; Konishi, M.; Ito, H.; Kumada, M. *J. Am. Chem. Soc.* **1982**, *104*, 4962. (b) Hayashi, T.; Konishi, M.; Kumada, M. *J. Am. Chem. Soc.* **1982**, *104*, 4963.
- For recent reviews, see: (a) Pereyre, M.; Quintard, J.-P.; Rahm, A. In *Tin in Org. Synth.*; Butterworths: London, 1987. (b) Curran, D. P. *Synthesis* **1988**, 489.
- For a review on the activating and directing effects of silicon, see: Bassindale, A. R.; Taylor, P. G. In *The Chemistry of Organic Silicon Compounds*; Patai, S., Rappoport, Z., Eds.; Wiley: New York, 1989; part 2, p 893. (b) For a recent theoretical study on the β -effect and leading references, see: Wirschke, S. G.; Chandrasekhar, J.; Jorgensen, W. L. *J. Am. Chem. Soc.* **1985**, *107*, 1496.
- Topsom, R. K. *Prog. Phys. Org. Chem.* **1976**, *12*, 1.
- Dewar, M. J. S.; Grisdale, P. J. *J. Am. Chem. Soc.* **1962**, *84*, 3549. (b) Charton, M. In *Correlation Analysis in Chemistry*; Chapman, N. B., Shorter, J., Eds.; Plenum Press: Ithaca, NY, 1960.
- Pitt, C. G. *J. Organomet. Chem.* **1973**, *61*, 49.
- Pauling, L. In *The Nature of the Chemical Bond*, 3rd ed.; Cornell University Press: Ithaca, NY, 1960.
- For a review on the use of the trimethylsilyl group as a protecting group in organic chemistry, see: Anderson, N. H.; McCrae, D. A.; Grotjahn, D. B.; Gabhe, S. Y.; Theodore, L. Y.; Ippolito, R. M.; Sarkar, T. K. *Tetrahedron* **1981**, *37*, 4069.
- Overman, L. E.; Blumenkopf, T. A. *Chem. Rev.* **1986**, *86*, 857.
- (a) Matassa, V. G.; Jenkins, P. R.; Kumin, A.; Damm, L.; Schreiber, J.; Felix, D.; Zass, E.; Eschenmoser, A. *Israel J. Chem.* **1989**, *29*, 321. (b) Denmark, S. E.; Weber, E. J.; Wilson, T. M. *Tetrahedron* **1989**, *45*, 1053.
- (a) Paddon-Row, M. N.; Rondan, N. G.; Houk, K. N. *J. Am. Chem. Soc.* **1982**, *104*, 7162. (b) Kahn, S. D.; Pau, C. F.; Chamberlin, A. R.; Hehre, W. J. *J. Am. Chem. Soc.* **1987**, *109*, 650. (c) Hoffmann, R. W. *Chem. Rev.* **1989**, *89*, 1841.
- The precise contribution of steric and electronic effects of the silyl group of the (*E*)-crotylsilane to the stereoselectivity of the reaction either in its transition state structure or the ground state are, of course, not known. However, for allylsilanes the conformational requirements seem to be well defined; for maximum stabilization of the carbocation β to the silicon group it is necessary for the C–Si bond to be oriented antiperiplanar to the emerging empty p-orbital (see ref 3a for a detailed discussion).
- Coppi, L.; Mordini, A.; Taddei, M. *Tetrahedron Lett.* **1987**, *28*, 969. For the preparation of the carbon-centered optically active silanes, see: Coppi, L.; Ricci, A.; Taddei, M. *Tetrahedron Lett.* **1987**, *28*, 965.
- Reetz, M. T.; Kessler, K. *J. Org. Chem.* **1985**, *50*, 5434.
- (a) Panek, J. S.; Yang, M. *J. Am. Chem. Soc.* **1991**, *113*, 6594. (b) Panek, J. S.; Yang, M. *J. Am. Chem. Soc.* **1991**, *113*, 9868. (c) Panek, J. S.; Yang, M.; Xu, F. *J. Org. Chem.* **1992**, *57*, 5790.
- Panek, J. S.; Yang, M.; Solomon, J. S. *J. Org. Chem.* **1993**, *58*, 1003.
- Panek, J. S.; Yang, M.; Muler, I. *J. Org. Chem.* **1992**, *57*, 4063.
- (a) Sparks, M. A.; Panek, J. S. *J. Org. Chem.* **1991**, *56*, 3431. (b) Sparks, M. A.; Panek, J. S. *Tetrahedron Lett.* **1991**, *32*, 4085. (c) Panek, J. S.; Clark, T. D. *J. Org. Chem.* **1992**, *57*, 4323.
- Nishigaichi, Y.; Takura, A.; Jodai, A. *Tetrahedron Lett.* **1991**, *32*, 2383.
- Nativi, C.; Palio, G.; Taddei, M. *Tetrahedron Lett.* **1991**, *32*, 1583.
- Wei, Z. Y.; Wang, D.; Li, J. S.; Chan, T. H. *J. Org. Chem.* **1989**, *54*, 5768. See also: Chan, T. H.; Wang, D. *Tetrahedron Lett.* **1989**, *30*, 3041. See also ref 3h.
- (a) Sommer, L. H.; Frye, C. L.; Parker, G. A.; Michael, K. W. *J. Am. Chem. Soc.* **1964**, *86*, 3271. (b) Corriu, R. J.; Massé, J. *Tetrahedron Lett.* **1968**, 5197. For a review of silicon-centered chirality: Maryanoff, C. A.; Maryanoff, B. E. In *Asymmetric Synthesis*; Academic Press Inc.: London, 1984; Chapter 5.
- Hathaway, S.; Paquette, L. A. *J. Org. Chem.* **1983**, *48*, 3351.
- Fleming, I.; Kindon, N. D.; Sarkar, A. K. *Tetrahedron Lett.* **1987**, *28*, 5921.
- Mikami, K.; Kawamoto, K.; Loh, T.-P.; Nakai, T. *J. Chem. Soc., Chem. Commun.* **1990**, 1161.
- Panek, J. S.; Cirillo, P. F. *J. Org. Chem.* **1994**, *59*, 5130.
- (a) Schinzer, D. *Synthesis* **1988**, 263. (b) Schinzer, D.; Allagannis, C.; Wichmann, S. *Tetrahedron* **1988**, *44*, 3851. (c) Molander, G. A.; Andrews, S. W. *Tetrahedron* **1988**, *44*, 3869.
- Denmark, S. E.; Almstead, N. G. *J. Org. Chem.* **1994**, *59*, 5130.
- Maier, M. E.; Schoffling, B. *Tetrahedron Lett.* **1990**, *31*, 3007.
- Jisheng, L.; Gallardo, T.; White, J. B. *J. Org. Chem.* **1990**, *55*, 5426.
- Mikami, K.; Maeda, T.; Kishi, N.; Nakai, T. *Tetrahedron Lett.* **1984**, *25*, 5151.
- Panek, J. S.; Masse, C. E. Unpublished results.
- Panek, J. S.; Sparks, M. A. *Tetrahedron Lett.* **1987**, *28*, 4649.
- Hiemstra, H.; Speckamp, W. N. In *Comprehensive Organic Synthesis*; Trost, B. M., Fleming, I., Eds.; Pergamon Press: Oxford, 1991; Vol. 4, Chapter 4.5.
- Panek, J. S.; Jain, N. F. *J. Org. Chem.* **1994**, *59*, 2674.

- (40) (a) Knölker, H.-J.; Foitzik, N.; Goesmann, H.; Graf, R. *Angew. Chem., Int. Ed. Engl.* **1993**, *32*, 1081. (b) Knölker, H.-J.; Graf, R. *Tetrahedron Lett.* **1993**, *34*, 4765. (c) Knölker, H.-J.; Foitzik, N.; Graf, R.; Pannek, J.-B. *Tetrahedron* **1993**, *49*, 9955. (d) Knölker, H.-J.; Graf, R. *Synlett.* **1994**, 131.
- (41) Monti, H.; Andran, G.; Monti, J.-P.; Léandri, G. *Synlett.* **1994**, in press.
- (42) (a) Danheiser, R. L.; Dixon, B. R.; Gleason, R. W. *J. Org. Chem.* **1992**, *57*, 6094. (b) Danheiser, R. L.; Takahashi, T.; Bertók, B.; Dixon, B. R. *Tetrahedron Lett.* **1993**, *34*, 3845.
- (43) Panek, J. S.; Jain, N. F. *J. Org. Chem.* **1993**, *58*, 2345.
- (44) Akiyama, T.; Yasusa, T.; Ishikawa, K.; Shoichiro, O. *Tetrahedron Lett.* **1994**, *35*, 8401.
- (45) Akiyama, T.; Ishikawa, K.; Ozaki, S. *Chem. Lett.* **1994**, 627.
- (46) Panek, J. S.; Yang, M. *J. Am. Chem. Soc.* **1991**, *113*, 9868.
- (47) Masamune, S.; Choy, W.; Petersen, J. S.; Sita, L. R. *Angew. Chem., Int. Ed. Engl.* **1985**, *24*, 1.
- (48) Panek, J. S.; Beresis, R. *J. Org. Chem.* **1993**, *58*, 809.
- (49) Shanamuganthan, K.; French, L. G.; Jensen, B. L. *Tetrahedron: Asymmetry* **1994**, *5*, 797.
- (50) (a) Simmons, H. E.; Smith, R. D. *J. Am. Chem. Soc.* **1958**, *80*, 5323. (b) Simmons, H. E.; Smith, R. D. *J. Am. Chem. Soc.* **1959**, *81*, 4256.
- (51) Henbest, H. B.; Wilson, R. A. L. *J. Am. Chem. Soc.* **1973**, 1958.
- (52) Sharpless, K. B.; Michaelson, R. C. *J. Am. Chem. Soc.* **1973**, *95*, 6136.
- (53) Panek, J. S.; Garbaccio, R. M.; Jain, N. F. *Tetrahedron Lett.* **1994**, *35*, 6453.
- (54) (a) Panek, J. S.; Zhang, J. *J. Org. Chem.* **1993**, *58*, 294. (b) Murphy, P. J.; Russell, A. T.; Proctor, G. *Tetrahedron Lett.* **1990**, *31*, 1055.
- (55) Panek, J. S.; Beresis, R. T. *J. Am. Chem. Soc.* **1993**, *115*, 7898.
- (56) Mohr, P. *Tetrahedron Lett.* **1993**, *34*, 6251.
- (57) For a review concerning the chemistry of propargylic anion equivalents, see: Epsztein, R. In *Comprehensive Carbanion Chemistry*; Buncl, E., Durst, T., Eds.; Elsevier: Amsterdam, 1984; part B, p 107.
- (58) (a) Danheiser, R. L.; Carini, D. J.; Kwasigroch, C. A. *J. Org. Chem.* **1986**, *51*, 3870. (b) Danheiser, R. L.; Carini, D. J. *J. Org. Chem.* **1980**, *45*, 3925.
- (59) (a) Danheiser, R. L.; Fink, D. M. *Tetrahedron Lett.* **1985**, *26*, 2513. (b) Buckle, M. J. C.; Fleming, I. *Tetrahedron Lett.* **1993**, *34*, 2383.
- (60) Marshall, J. A. *Chemtracts-Org. Chem.* **1992**, *5*, 75.
- (61) (a) Danheiser, R. L.; Carini, D. J.; Basak, A. *J. Am. Chem. Soc.* **1981**, *103*, 1604. (b) Danheiser, R. L.; Carini, D. J.; Fink, D. M.; Basak, A. *Tetrahedron* **1983**, *39*, 935.
- (62) Danheiser, R. L.; Kwasigroch, C. A.; Tsai, Y.-M. *J. Am. Chem. Soc.* **1985**, *107*, 7233.
- (63) Sakurai, H. In *Selectivities in Lewis Acid Promoted Reactions*; Schinzer, D., Ed.; Kluwer Acad. Press: Boston, 1989; p 203.
- (64) (a) Hosomi, A.; Kohra, S.; Ogata, K.; Yangi, T.; Tominaga, Y. *J. Org. Chem.* **1990**, *55*, 2415. (b) Kira, M.; Hino, T.; Sakurai, H. *Tetrahedron Lett.* **1989**, *30*, 1099. (c) Sato, K.; Kira, M.; Sakurai, H. *J. Am. Chem. Soc.* **1989**, *111*, 6429.
- (65) Kira, M.; Sato, K.; Sakurai, H. *J. Am. Chem. Soc.* **1988**, *110*, 4599.
- (66) Kobayashi, S.; Nishio, K. *J. Org. Chem.* **1994**, *59*, 6620.
- (67) Matsumoto, K.; Oshima, K.; Utimoto, K. *J. Org. Chem.* **1994**, *59*, 7152.

CR941081I